



A SELECTION OF OUR LATEST ARCHITECTURAL TILES

 **Waxman Ceramics**
Architectural Tiles

Head Office 01422 377123

Grove Mills
Elland
West Yorkshire
HX5 9DZ
England

Email info@waxmanarchitectural.co.uk
Web www.waxmanarchitectural.co.uk

Waxman Ceramics Architectural Tiles is a division of Waxman Ceramics Ltd - Part of the Waxman Group



MARBLE
STONE
CONCRETE
SOLID
STEEL
WOOD
TEXTILES
DESIGNER TILES
WINCKLEMANS

 **Waxman Ceramics**
Architectural Tiles

ARCHITECTURAL COLLECTION



VOLUME ONE

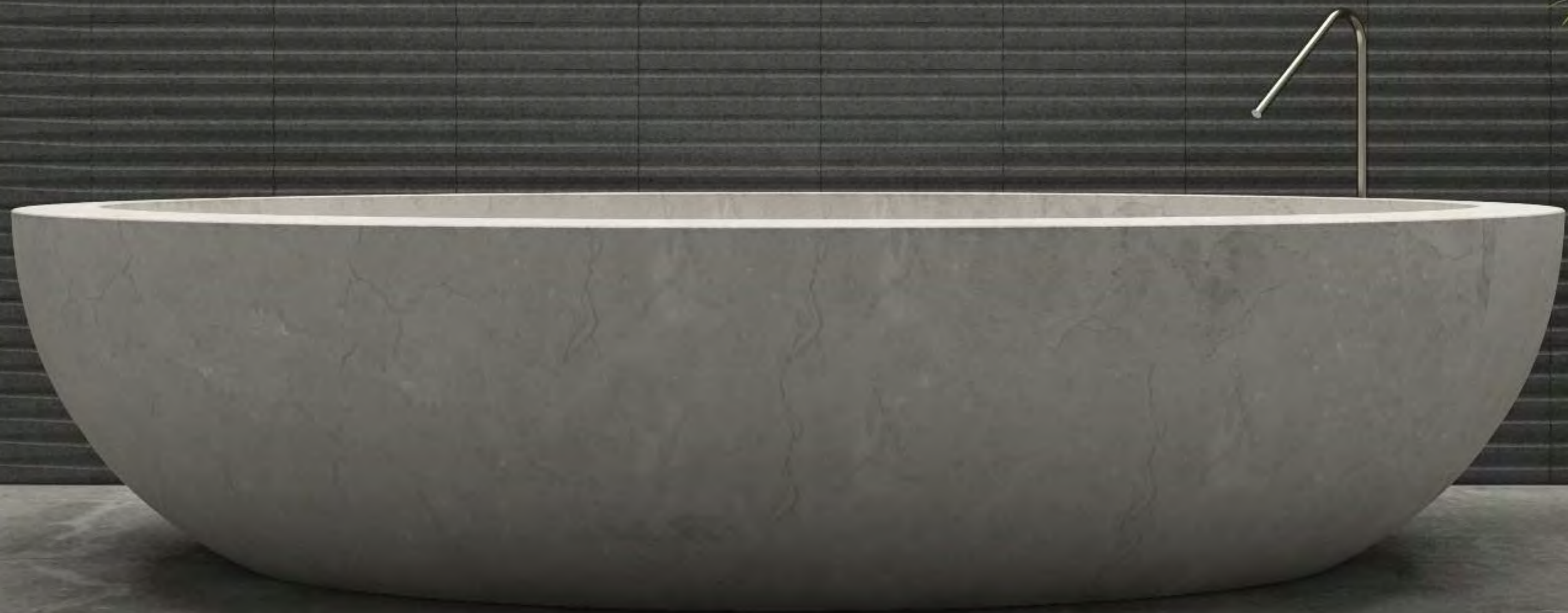

Rectified Tiles

Ceramic or porcelain tiles that have been precisely cut, ground and machined to give them near-perfect straight edges and exact dimensions. Providing a very clean, symmetrical look, and allow for extremely fine grout lines of 3mm or less. The machines used to cut them work to very fine tolerances.

Natural Finish

The surface of a Natural finished tile typically replicates the finish of the material on which it is based. For a stone and concrete effect tile, the surface will be very similar to the look and feel of the natural material, with its own unique markings, patterns and textures.

Polished Finish

During the finishing process each porcelain slab passes through a series of graded polishing wheels. These pads first grind and then buff the surface of the tile which gradually acquires a glossy, highly reflective appearance. We also have Semi-Polished sometimes related to as a Lappato Finish.

Anti-slip Finish

For use in wet areas such bathrooms, pool surrounds and shower areas, Anti-slip tiles offer a highly slip-resistant surface. Featuring a superfine 'sandpaper-like' texture they have been designed specifically for wet surface conditions where a slip resistant tile is required. Please note that while it is impossible to completely eliminate the risk of slipping, our Anti-slip tiles are suitable for public use facilities, and far exceed the recommendations from the UK HSE for flooring applications. Please note that all our 20mm tiles are available in Anti-slip.

Anti-Slip Rating Guide

Ramp Testing

DIN51130 - Shod traffic

DIN51097 - Barefoot

Classification	Angle
R9	6° < 10°
R10	10° < 19°
R11	19° < 27°
R12	27° < 35°
R13	> 35°

Classification	Angle
A	12° < 17°
B	18° < 23°
C	> 24°



Pendulum Testing

PTV = Pendulum Test Value

PTV Pendulum Test Result	Slip Potential
0 - 24	Dangerous or high potential for slipping
25 - 35	Marginal or moderate potential for slipping
36 - 65	Safe or low potential for slipping
66 +	Very safe or extremely low potential for slipping



The information contained within this document is, to the best of our knowledge, accurate at the time of production.

We reserve the right to modify this document at any time.

Whilst every attempt has been made to accurately reproduce colours and textures images used within this document are only intended as a guide.

Please refer to actual product samples before specifying or ordering.

REF: 20/07

ARCHITECTURAL COLLECTION



VOLUME ONE

MARBLE

- 4 Artisan
- 6 Colosseum
- 8 Le Grande
- 10 Phoenix

STONE

- 12 Nevada
- 14 Iconic
- 16 Construct 2.0
- 18 Tundra
- 20 Cascade
- 22 Hastings
- 24 Piedra
- 26 Ronda
- 28 Zurich

CONCRETE

- 30 Belgravia
- 32 Crete
- 34 Crete Plus
- 36 Punto
- 38 Cement

SOLID

- 40 Block

STEEL

- 42 Zincato
- 44 Corten

WOOD

- 46 Segano
- 48 Kielder
- 50 Albero

TEXTILES

- 52 Weave
- 54 Stucco

DESIGNER TILES

- 56 Geo Cubic
- 58 Geo Cubic Decor
- 60 Geo Rhombus
- 62 Geo Lantern
- 64 Geo Hex
- 66 Geo Hex Decor
- 68 Geo Sector
- 70 Geo Tri
- 72 Palma
- 74 Dorset
- 76 Havana
- 78 Downtown
- 80 Split
- 82 Manila
- 84 N Series
- 86 Apoidea
- 90 Textura 1
- 92 Textura 2
- 94 Kayama
- 96 Diamond
- 98 Geo Floor
- 100 Geo Wood Floor
- 102 Monumenta
- 104 Vintage
- 108 Arte Di Casa
- 112 Barcelona

WINCKLEMANS

- 116 Introduction & Format & Colours
- 118 Squares
- 120 Rectangles
- 122 Hexagons
- 124 Octagons & Dots
- 126 Triangles
- 128 Rounds & Diamonds
- 130 Mosaic Combinations
- 132 Designs & Borders
- 136 Encaustic



About Waxman Architectural

Based in Elland, West Yorkshire, and with a network of specification specialists across the UK, Waxman Ceramic Architectural Tiles provide solutions for industry professionals looking for a wide range of high-quality tiles for even the most challenging commercial specifications.

As the specification division of Waxman Ceramics, we have long-standing relationships with some of the world's most influential manufacturers - from both a design and technical standpoint. Working alongside designers, architects and building services professionals, we help clients fulfil design briefs in both residential and commercial properties including; hotels, leisure centres and restaurants amongst many other industries.

Bespoke Service

From creating bespoke Victorian floor designs to commissioning unique mosaic blends to meet specific design criteria, our attention to detail, coupled with highest quality customer support, has made Waxman the supplier of choice for clients looking to balance creativity, budget and technical ability.

Waxman Architectural has an enviable client list, developed over many years, as our unrivalled product knowledge and customer service provide a complete solution for anyone in the building industry. Examples of our work can be seen throughout the United Kingdom; high street brands, UK landmarks, hotel chains, heritage sites and sporting venues have all selected Waxman Architectural as a key partner for their respective projects.



Also available from our extensive range of tiles

Simply request a copy from Waxman Ceramics, contact us now on 01422 377123 or visit us at www.waxmanarchitectural.co.uk and download your brochure today.

Contract Tile Collection



Mosaic Collection



Tile Collection



Pool & Spa Collection



Tile Types and Specifying Slip-Resistant Tiles

As one of the UK's leading suppliers of commercial wall and floor tiles, we are keen to share our expert industry knowledge by offering a RIBA accredited CPD seminar in 'Tile Types and Specifying Slip-Resistant Tiles'.

Held in your place of work, this 1 hour seminar covers the technical characteristics of ceramic and porcelain tiles and provides help and advice on specifying tiles to suit specific environments when considering slip resistance.

For more information or to book a seminar, please get in touch

Email Us:
info@waxmanceramics.co.uk

Call Us:
01422 377123



ARTISAN

A TOUCH OF CLASS

Available in Natural and Polished

Imperial Grey

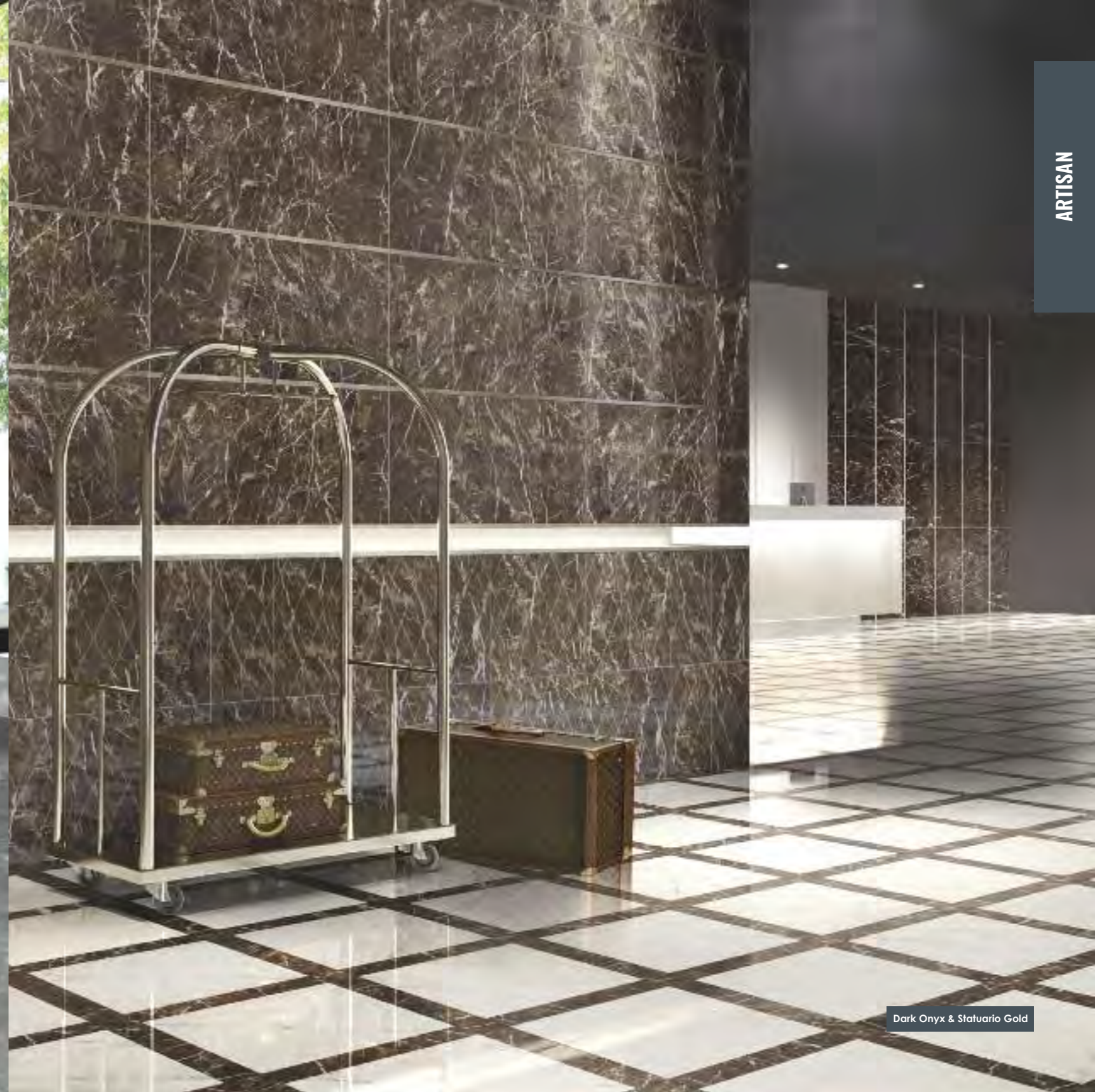

Dark Onyx & Statuario Gold

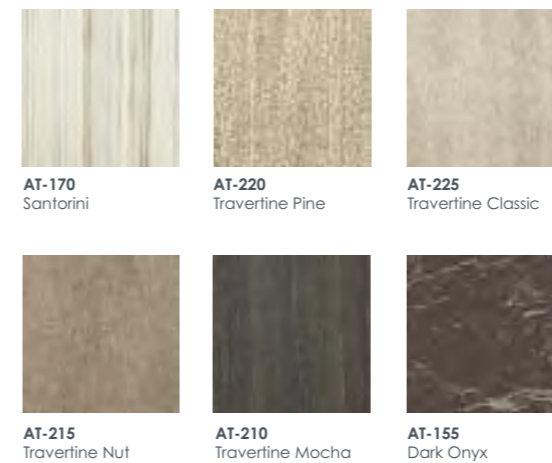
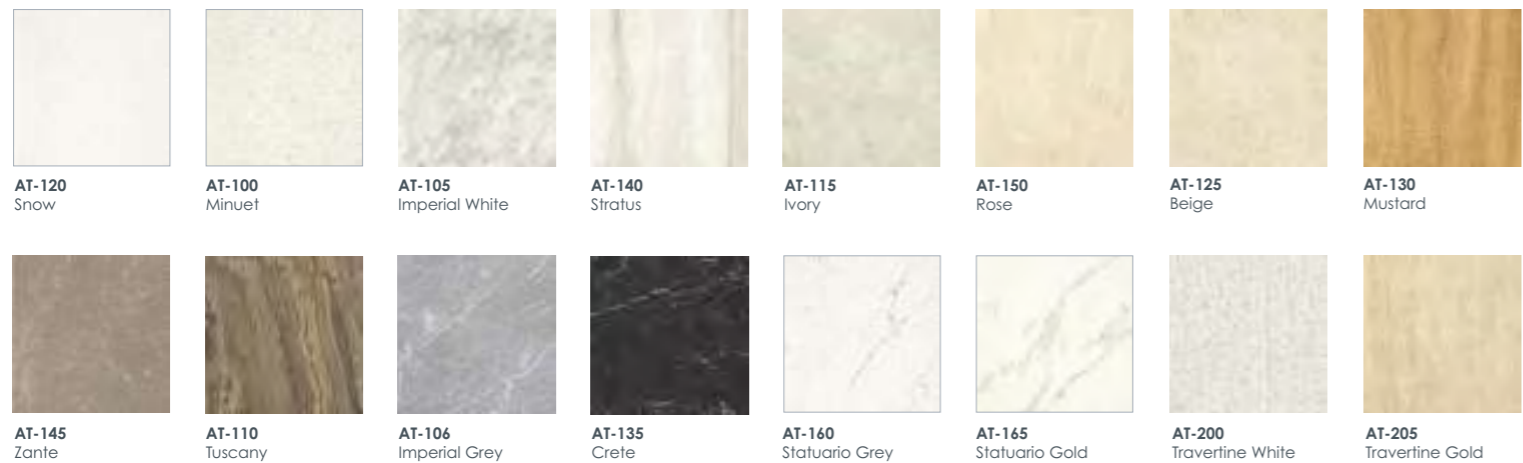

All colours are available in both Natural & Polished finishes in all sizes

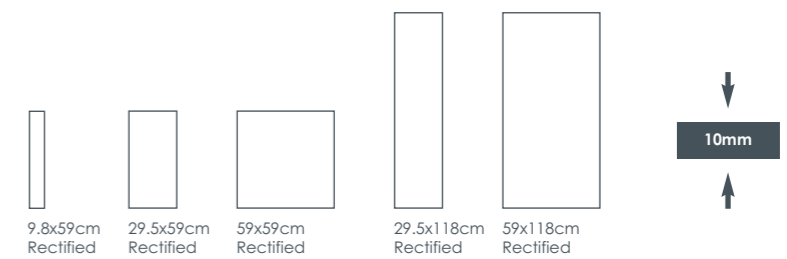



COLOSSEUM

DURABLE ELEGANCE

Lara



CL-130
Crema Marfil



CL-132
Lara



CL-134
Macael



CL-140
Luna Blanco



CL-141
Luna Marron



CL-142
Luna Dark Grey

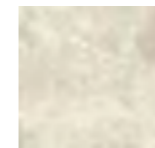

CL-143
Luna Beige



CL-150
White



CL-151
Black



10mm



10x60cm
Rectified



15x60cm
Rectified



30x60cm
Rectified



11mm



40x80cm
Rectified



60x60cm
Rectified



12mm



80x80cm
Rectified



60x120cm
Rectified

Available in a **Natural** and **Polished** finish

Please refer to technical pdf for availability of sizes and finishes

Mosaic decors are available



Excellent Scratch Resistance



LAVISH DELUXE | LE GRANDE

Bianco Calacatta

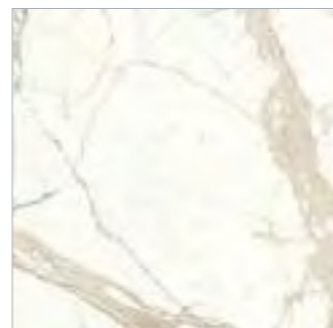

LG-03 Bianco Calacatta

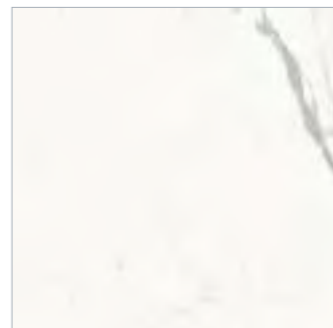

LG-36 Statuario

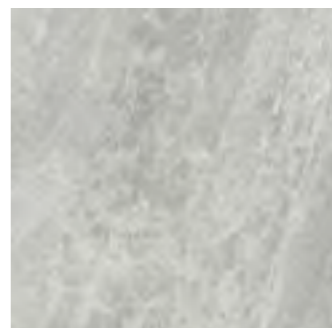

LG-22 Gris De Savoie

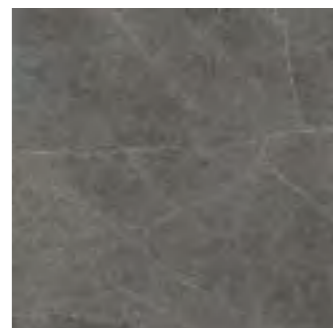

LG-20 Grey Marble

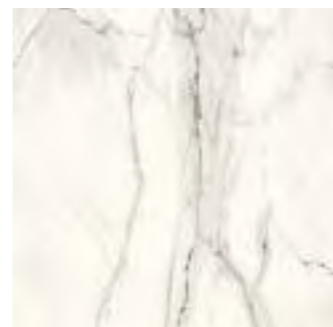

LG-10 Calacatta Lincoln

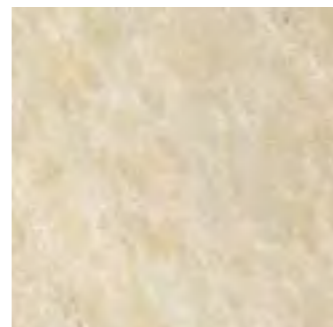

LG-13 Crema Marfil

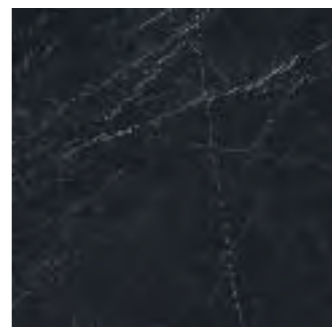

LG-23 Nero Marquina



LG-40 Thassos

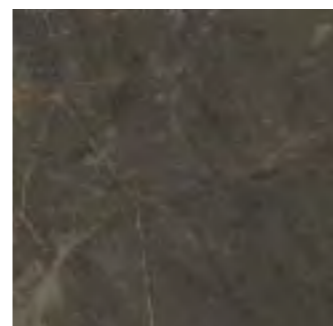

LG-32 Pulpis Grey

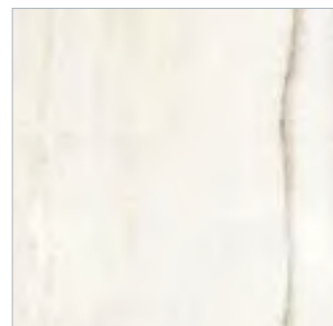

LG-53 Onice Perato

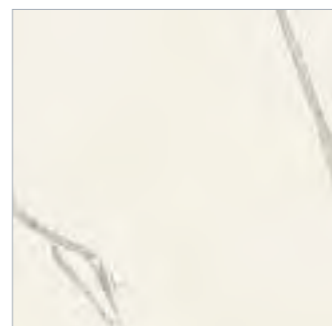

LG-37 Statuario Ultra

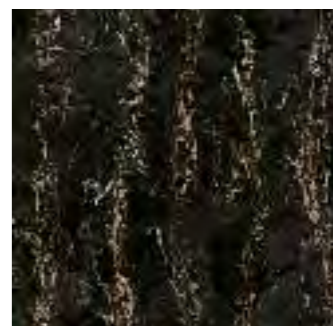

LG-28 Porte D'Or



LG-38 Statuario Ultra Block A 150x300cm



LG-39 Statuario Ultra Block B 150x300cm

Classic



8mm



30x60cm Rectified



60x60cm Rectified



120x120cm Rectified

Slim



6mm



37.5x75cm Rectified



75x75cm Rectified



100x100cm Rectified



75x150cm Rectified

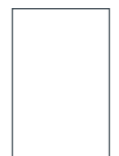

100x150cm Rectified



150x150cm Rectified

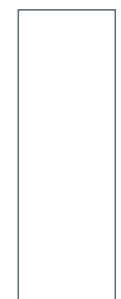

100x300cm Rectified



150x300cm Rectified

Available in Shiny, Soft and Polished finishes
Please refer to technical pdf for availability of sizes and finishes

PHOENIX

Inspired by
the beautiful
Pulpis Marble



Blanco



Gris

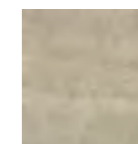

Crema



Natural

Glazed Ceramic

Wall Tiles - Gloss finish

- Blanco PX-11
- Gris PX-12
- Crema PX-13
- Natural PX-14



31.6x90cm

Glazed Porcelain

Matt & Polished finish

- Blanco PX-21
- Gris PX-22
- Crema PX-23
- Natural PX-24



45x118cm
Rectified



75x75cm
Rectified



10mm



Decors and special pieces are available

Crema & Natural

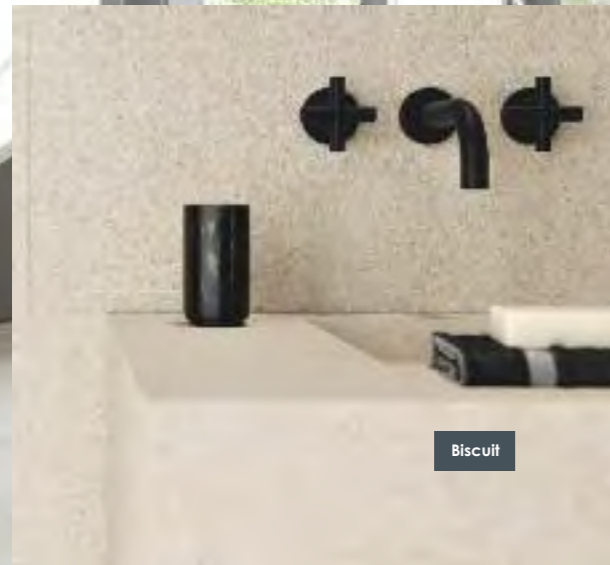

Biscuit

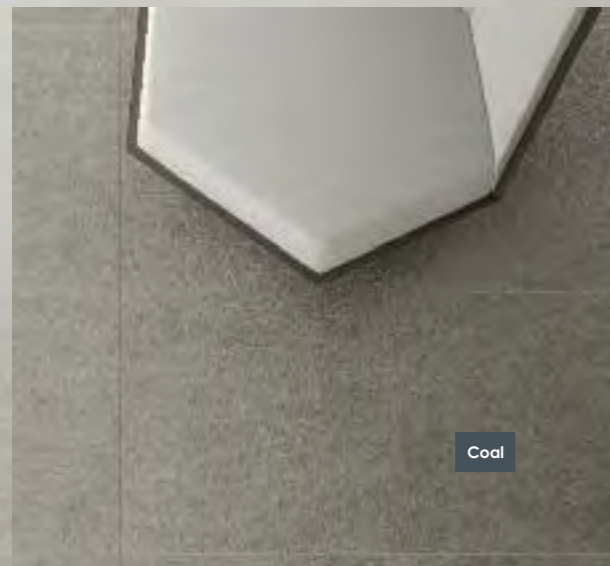

Cool

NEVADA

SLEEK LIMESTONE STYLE



NV-111
White



NV-112
Light Grey



NV-113
Biscuit



NV-114
Greige



NV-115
Dark Grey

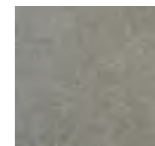

NV-116
Coal



NV-117
Black



5x60cm
Rectified



10x60cm
Rectified



30x60cm
Rectified



60x60cm
Rectified



120x120cm
Rectified

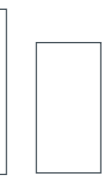

45x90cm
Rectified



90x90cm
Rectified

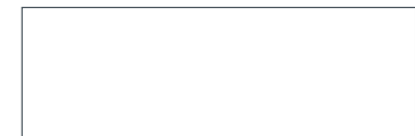

90x270cm
Rectified

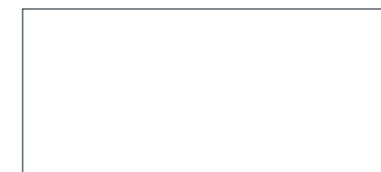

120x260cm
Rectified

Natural finish:

Available in all colours and sizes
Rating: Shod PTV +36

Bush Hammered finish:

Available in all colours and sizes except
120x260cm & 90x270cm
Rating: Shod R10 - PTV +36, Barefoot B

Anti-Slip finish:

Available in all colours and sizes except
120x260cm & 90x270cm
Rating: Shod R11 - PTV +36, Barefoot B

Decors and special pieces are available

Greige

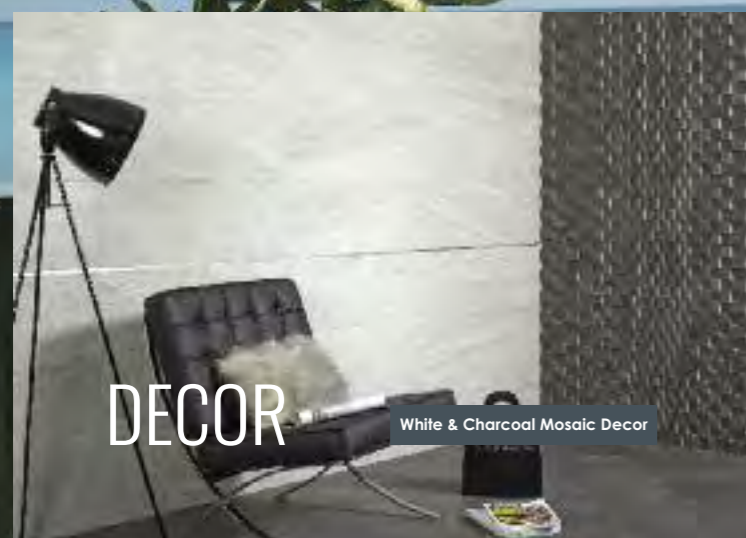

ICONIC

INSIDE/OUTSIDE

Charcoal

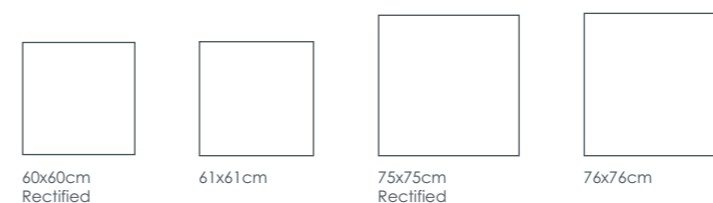
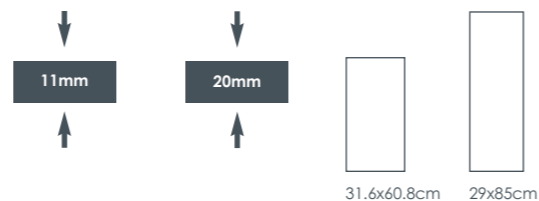

Thickness: 11mm
 Sizes available: 60x60cm, 31.6x60.8cm, 75x75cm, 76x76cm, 29x85cm
Natural finish Rating: Shod PTV +36

Thickness: 20mm
 Sizes available: 60x60cm, 61x61cm, 75x75cm, 76x76cm
Anti-Slip finish available in all sizes and colours except 75x75cm and 76x76cm
 is not available in White and Beige
 Anti-Slip Rating: Shod R11 - PTV +36, Barefoot PTV +36
 Decors and special pieces are available



CLEAN
CLASSIC
CONTEMPORARY

Cream & White



CONSTRUCT 2.0

Charcoal, Grey, Pale Grey & White



CN-200 Dove Grey CN-202 Linen CN-204 Cream CN-206 White CN-208 Pale Grey CN-210 Grey CN-212 Charcoal



9.2mm

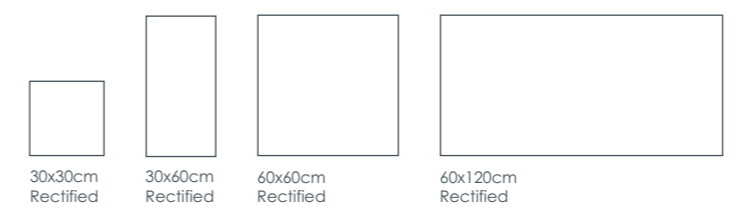

30x30cm Rectified 30x60cm Rectified 60x60cm Rectified 60x120cm Rectified

Natural finish available in all sizes & colours
 Natural Rating: Shod R9 - PTV +36
Polished finish available in 30x60cm, 60x60cm & 60x120cm, in all colours
Textured finish available in 30x60cm & 60x60cm, in all colours
 Textured Rating: Shod R11 - PTV +36, Barefoot C - PTV +36
 Decors and special pieces are available



TN-52 Blanco

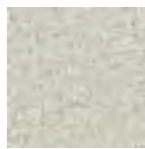

TN-53 Gris



TN-54 Antracita



TN-55 Negro



30x60cm Rectified



60x60cm Rectified



80x80cm Rectified



Natural finish

Available in all colours and sizes
Rating: Shod R10 - PTV +36, Barefoot B

Lapado finish

Available in all colours and sizes

TUNDRA

ROBUST STONE EFFECT

Gris



CASCADE

LAPPATO FINISH

Graphite



CHEVRON DECOR

LINEA DECOR

Graphite

Cement



CASCADE

A SOPHISTICATED
ALTERNATIVE TO
SLATE

CASCADE

Black

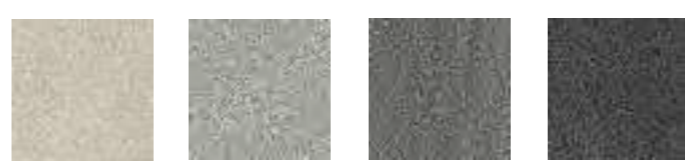

CS-21 Sand, CS-22 Cement, CS-23 Graphite, CS-24 Black

Thickness: 10.5mm
Natural finish available in all sizes and colours
 Natural Rating: Shod R10 - PTV +36, Barefoot B
Lappato finish available in all sizes and colours
Anti-Slip finish available in 60x60 Rectified in all colours
 Anti-Slip Rating: Shod R11 - PTV +36, Barefoot C - PTV +36

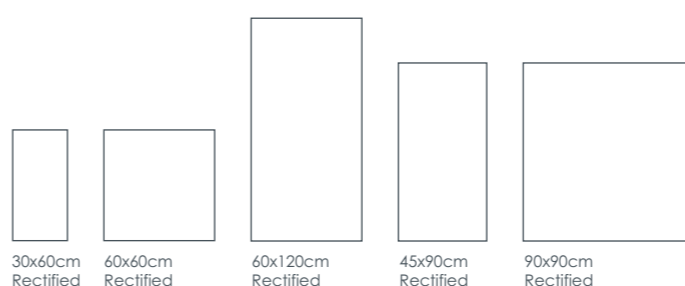

Thickness: 20mm
 Sizes available: 45x90cm Rectified
Anti-Slip finish available in all colours
 Anti-Slip Rating: Shod R11 - PTV +36, Barefoot C - PTV +36
 Decors and special pieces are available

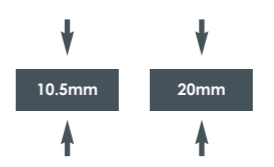

STUNNING STONE
Available in Natural and Textured Finish



HASTINGS



Stone

Graphite



HS-525
White



HS-526
Stone



HS-527
Graphite



All colours are available in both **Natural & Textured** finish in all sizes

Textured finish Rating: Shod R10 - PTV +36, Barefoot B



50x100cm
Rectified



100x100cm
Rectified



100x150cm
Rectified



150x150cm
Rectified



150x300cm
Rectified



PIEDRA

PIEDRA

Create your perfect space PIEDRA

Sand

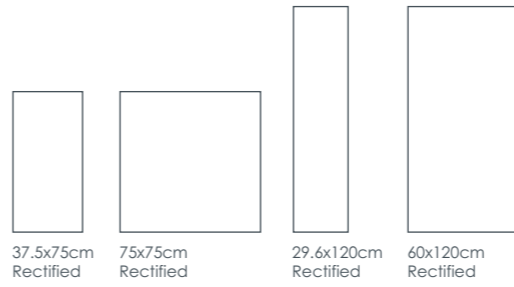
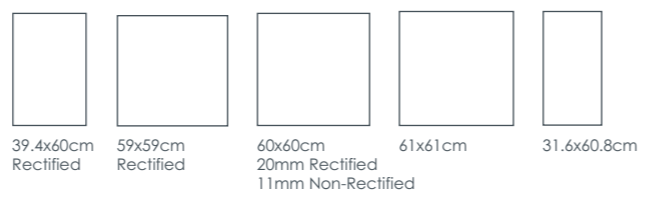

Thickness: 11mm
Natural finish available in sizes 59x59cm, 31.6x60.8cm, 75x75cm, 60x120cm in all colours
 Natural Rating: Shod R10 - PTV +36
Anti-Slip finish available in sizes 60x60cm and 37.5x75cm in colours Beige, Mist and Anthracite
 Anti-Slip Rating: Shod R11 - PTV +36, Barefoot PTV +36

Thickness: 20mm
 Sizes available: 39.4x60cm, 60x60cm, 61x61cm, 29.6x120cm, 60x120cm
Anti-Slip finish available in all colours
 Anti-Slip Rating: Shod R11 - PTV +36, Barefoot PTV +36
 Decors and special pieces are available



SET THE TONE WITH
BEAUTIFUL STONE
Available in Natural and Anti-Slip Finish

Rosalejo



RONDA

Novares



RN-26
Arriale



RN-27
Los Morales



RN-28
Novares



RN-29
Rosalejo



10mm



Thickness: 10mm
Natural finish available in all sizes & colours
Rating: Shod R10 - PTV +36, Barefoot B
Anti-Slip finish available in 60x60cm
Anti-Slip Rating: Shod R11 - PTV +36,
Barefoot C - PTV +36



20mm



Thickness: 20mm
Anti-Slip finish available in 60x60cm in all
colours. Rating: Shod R11 - PTV +36,
Barefoot C - PTV +36

Special pieces are available



20x60cm
Rectified



30x60cm
Rectified



40x60cm
Rectified



60x60cm
Rectified



60x90cm
Rectified



90x90cm
Rectified



60x120cm
Rectified



ZURICH

Stone



ZURICH

BOLD TERAZZO EFFECT ZURICH

Marine

		
ZR-230 Chalk	ZR-231 Sand	ZR-232 Stone
		
ZR-233 Graphite	ZR-234 Forest	ZR-235 Marine

Natural finish available in all sizes & colours

Textured finish available in Chalk, Sand, Stone and Graphite
 Sizes available: 50x100cm, 100x100cm
 Textured Rating: Shod R10 - PTV +36
 Special pieces are available

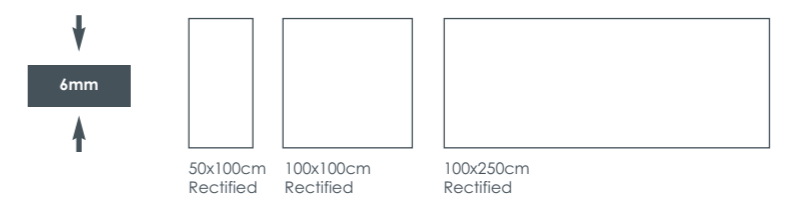

STYLISH CONCRETE

Available in Natural and 20mm Anti-Slip



Charcoal & Grey



Charcoal

BELGRAVIA

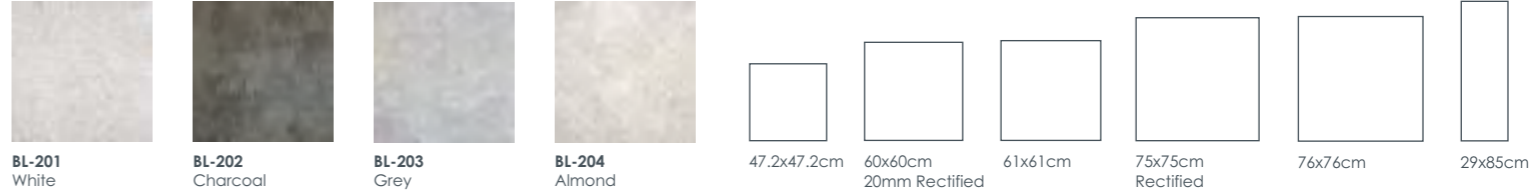

11mm

Natural finish
 Thickness: 11mm
 Sizes available: 60x60cm, 75x75cm, 76x76cm, 29x85cm
 Available in all colours

20mm

Anti-Slip finish available in Charcoal & Grey
 Thickness: 20mm
 Sizes available: 47.2x47.2cm, 60x60cm, 61x61cm, 75x75cm, 76x76cm
 Anti-Slip Rating: Shod R11 - PTV +36, Barefoot PTV +36



Armeni



20mm

Lentas 20mm

CRETE

DECORATIVE CONCRETE

Skopi Decor



CR-200 Armeni CR-201 Lentas CR-202 Malia CR-203 Pompia CR-204 Skopi CR-205 Ziros

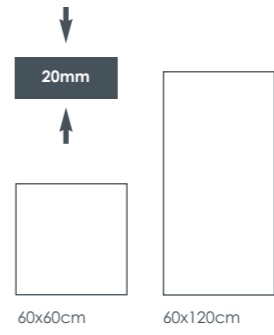
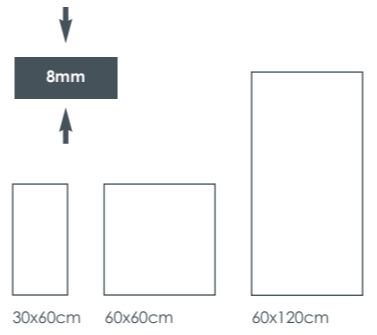
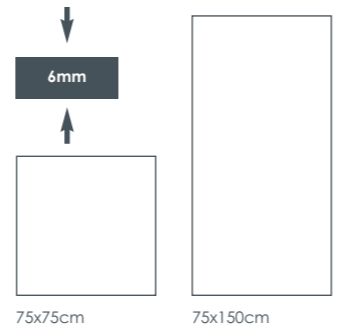

Thickness: 6mm / 8mm
Natural finish available in all sizes and colours
 Natural Rating: Shod R10 - PTV +36
 Decor available in 60x60cm in all colours

Thickness: 20mm
 Sizes available: 60x60cm, 60x120cm
Textured finish available in all colours
 Textured Rating: Shod R11 - PTV +36, Barefoot B
 Special pieces are available

CRETE PLUS

SUPERSIZED STYLE



CR-301
Lentas Plus



CR-302
Malia Plus



CR-305
Ziros Plus



CR-304
Skopi Plus



100x100cm



100x150cm



100x300cm



6mm



Natural finish Rating: Shod R10
Special pieces are available

Lentas Plus & Skopi Plus

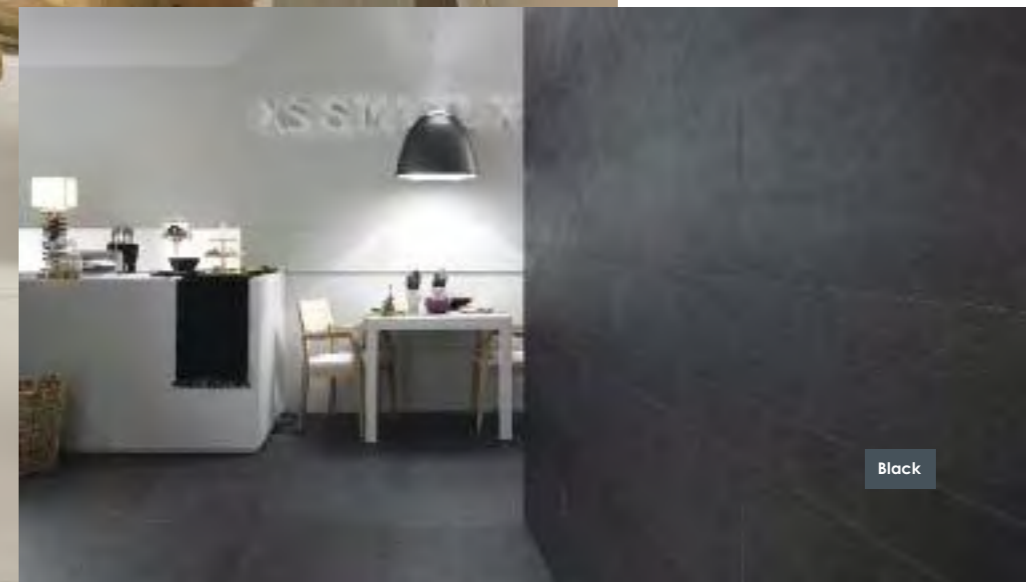
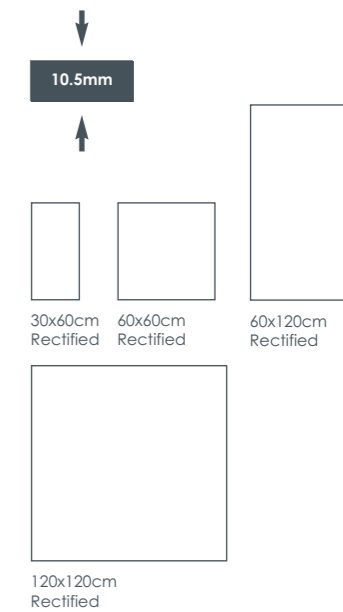
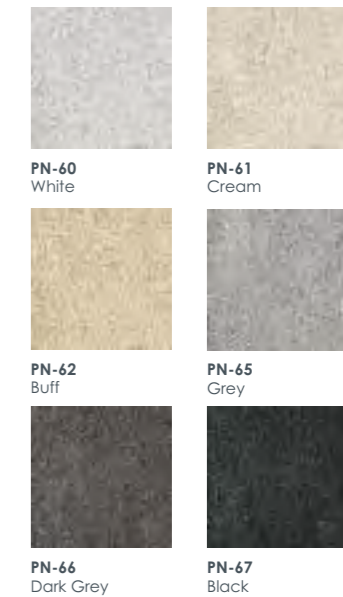

PRETTY &
PRACTICAL

PUNTO

Cream & White

Natural finish:
Available in all sizes and colours
Rating: Shod R10
Lappato finish available in 60x60cm, 60x120cm and 120x120cm
Textured finish available in sizes 30x60cm & 60x60cm in all colours.
Rating: Shod R11 - PTV +36, Barefoot B
Decors and special pieces are available

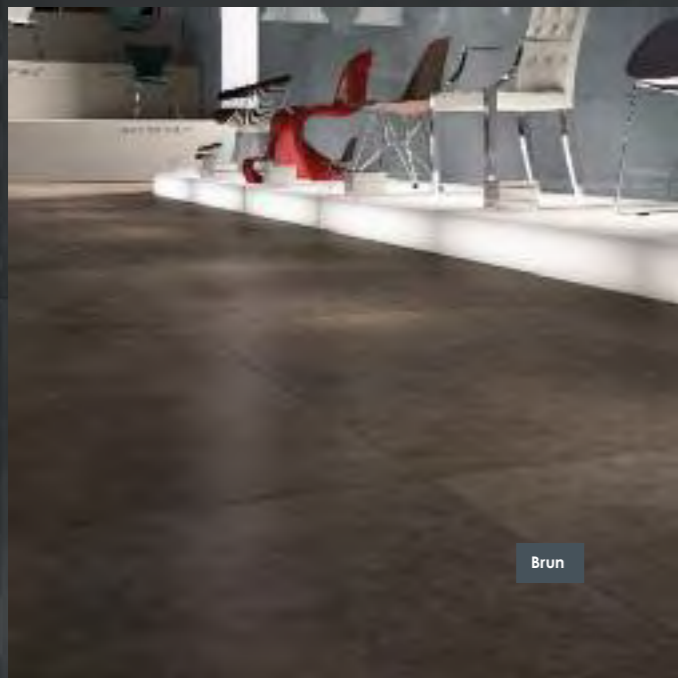

Brun

NEUTRAL MODERNISM

Available in Natural, Polished and Textured Finish



Grey



CEMENT

White



CM-30 White
 CM-31 Almond
 CM-32 Beige
 CM-33 Brun
 CM-34 Pale Grey
 CM-35 Grey
 CM-36 Anthracite
 CM-37 Midnight

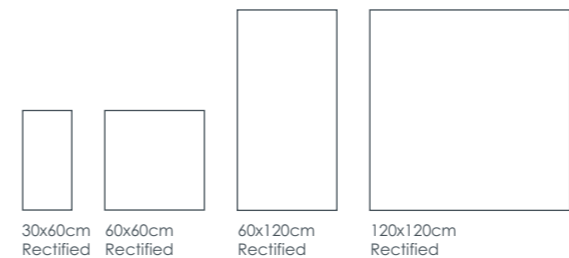

30x60cm Rectified
 60x60cm Rectified
 60x120cm Rectified
 120x120cm Rectified



10.5mm

Natural finish available in all sizes and colours
Natural Rating: Shod R10

Polished finish available in all sizes and colours

Textured finish available in 30x60cm & 60x60cm, in all colours
Textured Rating: Shod R11 - PTV +36, Barefoot C - PTV +36

Decors and special pieces are available

BLOCK

SIMPLY SLEEK



BK-70
Super White

BK-71
White

BK-72
Beige



BK-73
Taupe

BK-74
Khaki

BK-75
Brown



BK-76
Greige

BK-77
Grey

BK-78
Ash



BK-79
Graphite

BK-80
Black

BK-81
Super Black

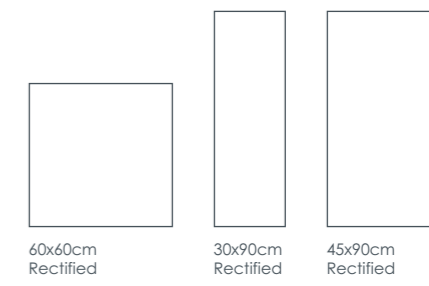

Natural finish:
Available in all colours and sizes
Rating: Shod PTV +36

Riven finish:
Available in all colours and sizes
Rating: Shod R10 - PTV +36, Barefoot PTV +36

Textured finish:
Available in all colours and sizes
Rating: Shod R11 - PTV +36, Barefoot PTV +36

Decors and special pieces are available

ZINCATO

AUTHENTIC URBAN CHIC



Blanco

Gris

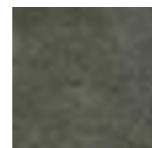

ZN-380
Nero



ZN-382
Marron



ZN-384
Gris



ZN-386
Bianco



30x60cm
Rectified



60x60cm
Rectified



60x120cm
Rectified



Natural finish:
Available in all sizes and colours
Special pieces are available



CORTEN

Night



INSPIRED BY DISTRESSED STEEL

Oxide



CT-60
Cloud



CT-61
Oxide

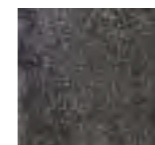

CT-62
Night

10mm



60.7x60.7cm
Reclified

11mm



60.7x120.7cm
Reclified

Natural finish:
Rating: Shod R10 +36

Lappato finish:
All colours are available in both sizes and finishes

Decors and special pieces are available



SEGANO

Self-levelling porcelain tiles
which adapt to most surfaces

SG-722
Ash

SG-720
Marron

SG-721
Nut

9mm

20x170cm
Rectified

FLEXIBLE

Natural finish Rating: Shod PTV +36
Special pieces are available

Traditional System Installation

- Segano's self-levelling technology makes for easier installation on uneven floors. This means that surfaces require less preparation, aiding faster application.
- Manufactured using raw materials with high plasticity to facilitate flexibility.
- Highly durable, yet extremely flexible.
- The weight and flexibility of Segano means that self-levelling is possible to increase application versatility.
- The large 20x170cm size of Segano means that installation is much quicker and easier.

Dry System Installation

- Segano offers a new and adaptable installation system that means adhesives and joints are no longer required; a great solution for quick and easy fitting.
- Due to Segano's dry system installation, the removal of tiles is also quick and easy.
- Without the need for grout and adhesive, Segano can be walked upon as soon as it's laid.
- Segano is increasingly adaptable and can be re-used in various dry system installations. This makes it a cost effective surface solution.

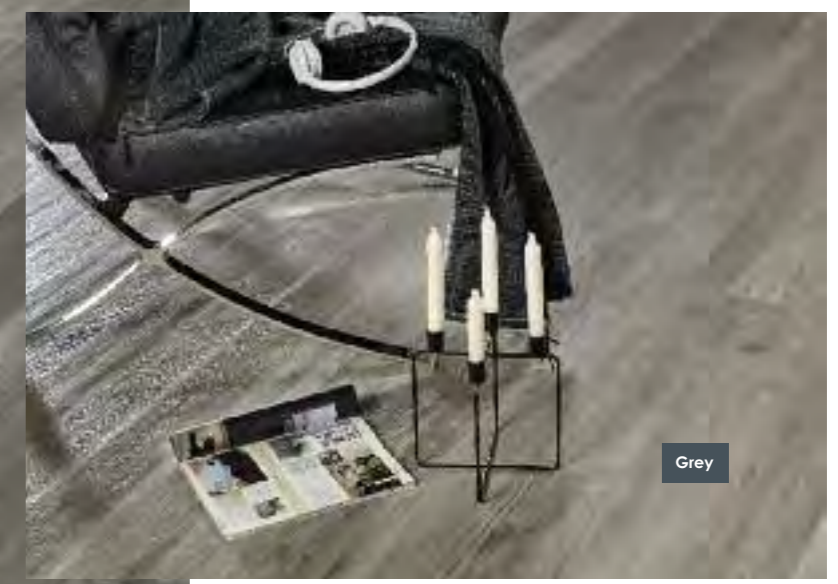

Ash

Grey



White

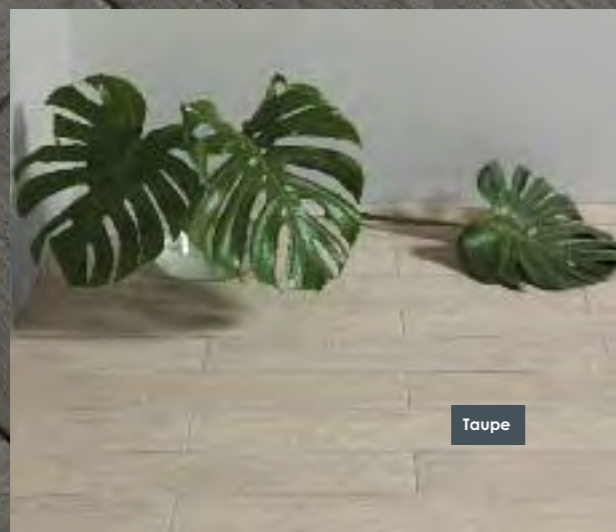

Taupe



Pink

KIELDER

CONTEMPORARY WOOD

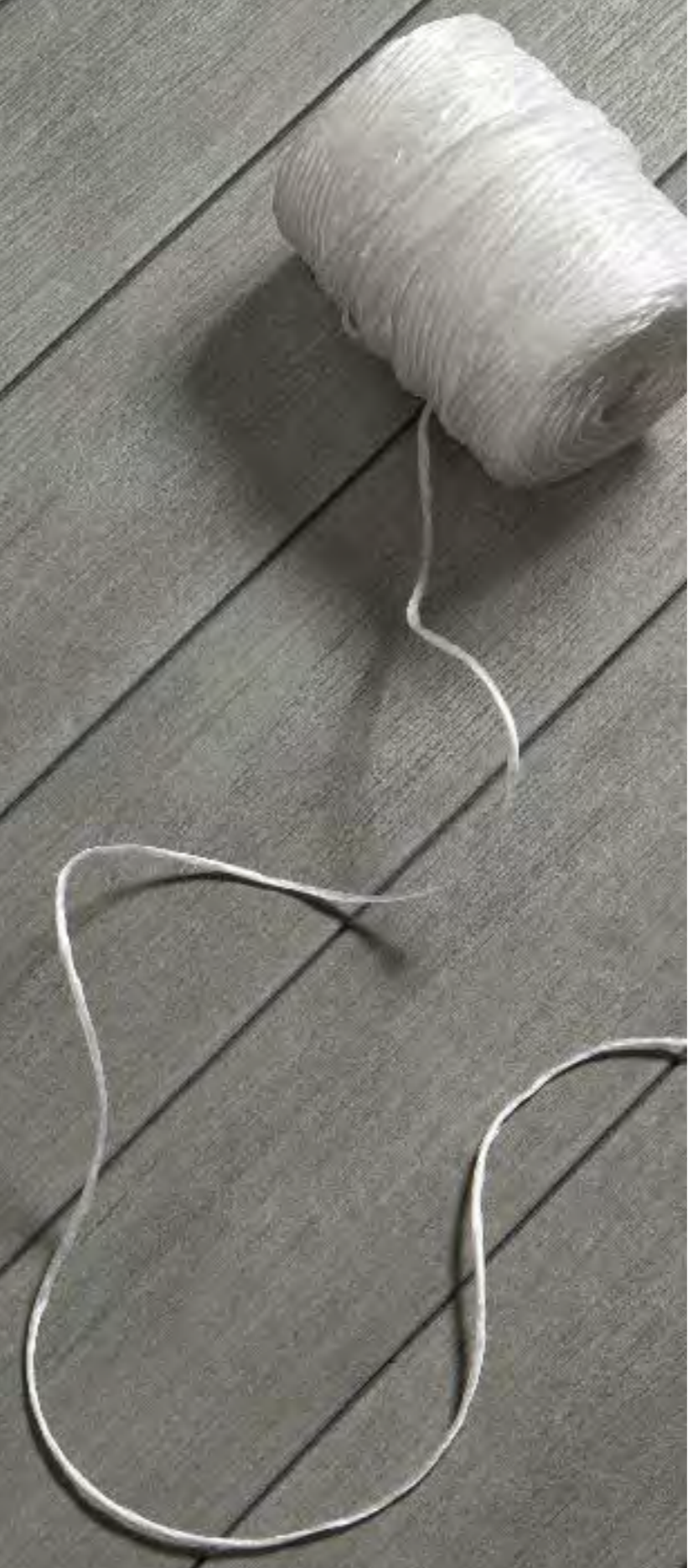

KD-84
White



KD-85
Taupe



KD-86
Pink

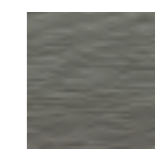

KD-87
Anthracite

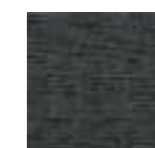

KD-88
Green

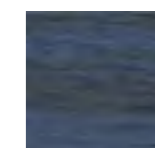

KD-89
Blue

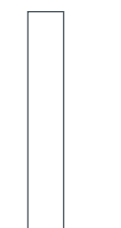

9.8x59.3cm

Matt finish
Rating: Shod PTV +36

Anthracite



Nature



Mink



Smoke

ALBERO

LIVING WITH NATURE



White



AB-71
White



AB-72
Light



AB-73
Smoke

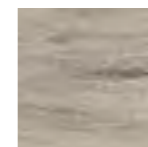

AB-74
Mink

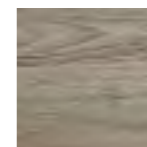

AB-75
Nature



Mosaico - Smoke
30x30cm
11.5mm



3D - Smoke
28x28cm
11.5mm



Plank - Smoke
35x60cm
11.5mm



19.4x120cm
Rectified



29.5x120cm
Rectified



Natural finish available in all colours in size 19.4x120cm
Decors available in all colours.
Natural Rating: Shod PTV +36

Anti-Slip finish available in 29.5x120cm Light, Smoke, Mink & Nature
and 19.4x120cm Light, Smoke & Nature.
Anti-Slip Rating: Shod R11 - PTV +36, Barefoot PTV +36



Abstract Dec - Grey

WEAVE

A STYLISH NATURAL WOVEN EFFECT WITH AN ABSTRACT DECOR

Grey



WV-46
Linen



WV-47
Grey



WV-48
Taupe



WV-49
Ecu

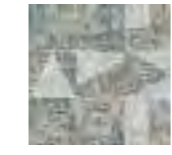

WV-50/AB
Abstract Dec - Grey
60x60cm
90x90cm



WV-50/CR
Circle Dec - Grey
30x30cm
60x60cm

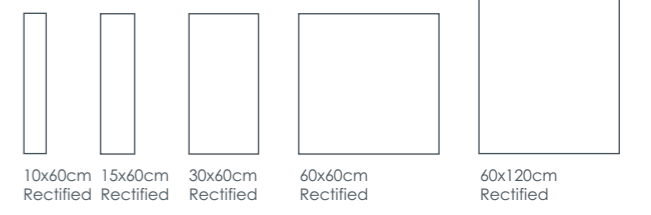

Natural finish Rating: Shod R10

UNIQUE TEXTURED TILES



Crochet

STUCCO



Cinder & Grey



Chequer



ST-41
Pearl



ST-42
Cinder



ST-43
Grey

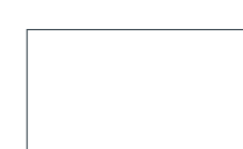

75x150cm
Rectified



11mm



75x75cm
Rectified



37.5x75cm
Rectified



10.2mm

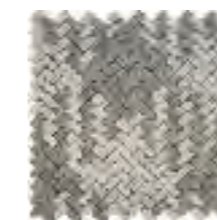

ST-49
Mosaic Multi Mix
30x30cm
10.2mm

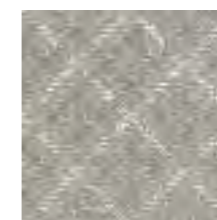

ST-47
Chequer
37.5x75cm & 75x75cm
10.2mm



ST-41/C
Crochet
37.5x75cm
10.2mm

Natural finish:

Available in all colours and sizes
Natural Rating: Shod R10

Anti-Slip finish:

Available in all colours in 37.5x75cm & 75x75cm
Anti-Slip Rating: Shod R13 - PTV +36, Barefoot PTV +36

Lappato finish:

Available in all colours in 37.5x75cm & 75x75cm
Lappato Rating: Shod R10 - PTV +36, Barefoot PTV +36







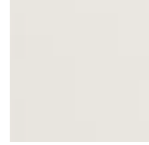

Textured finish:

Available in all colours in 37.5x75cm & 75x150cm
Textured Rating: Shod R11 - PTV +36, Barefoot PTV +36

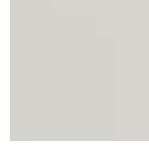
ST-47 Chequer available in sizes 37.5x75cm & 75x75cm
Chequer Rating: Shod R12 - PTV +36, Barefoot PTV +36

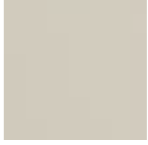
GEO CUBIC

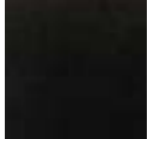

 GE-50 Gloss White ●	 GE-51 Matt White ■	 GE-52 Cream ●
 GE-53 Pale Grey ●	 GE-54 Green Tint ●	 GE-55 Blue Tint ●
 GE-56 Almond ●	 GE-57 Dark Grey ●	 GE-61 Gloss Black ●
 GE-62 Matt Black ■	 GE-58* Honey ●	 GE-59* Cobalt ●
 GE-60* Victorian Green ●		

* Made using special enamels with a tendency to have a natural cracking effect and have low resistance to acids and strong cleaning products.

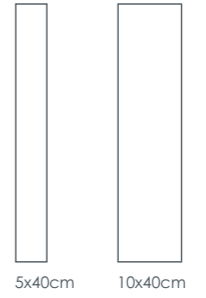
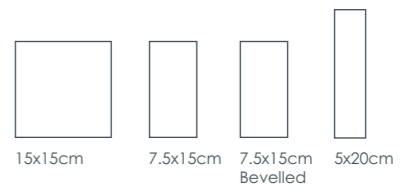

Matt finish: ■
Gloss finish: ●

Please refer to pdf for availability of sizes and colour

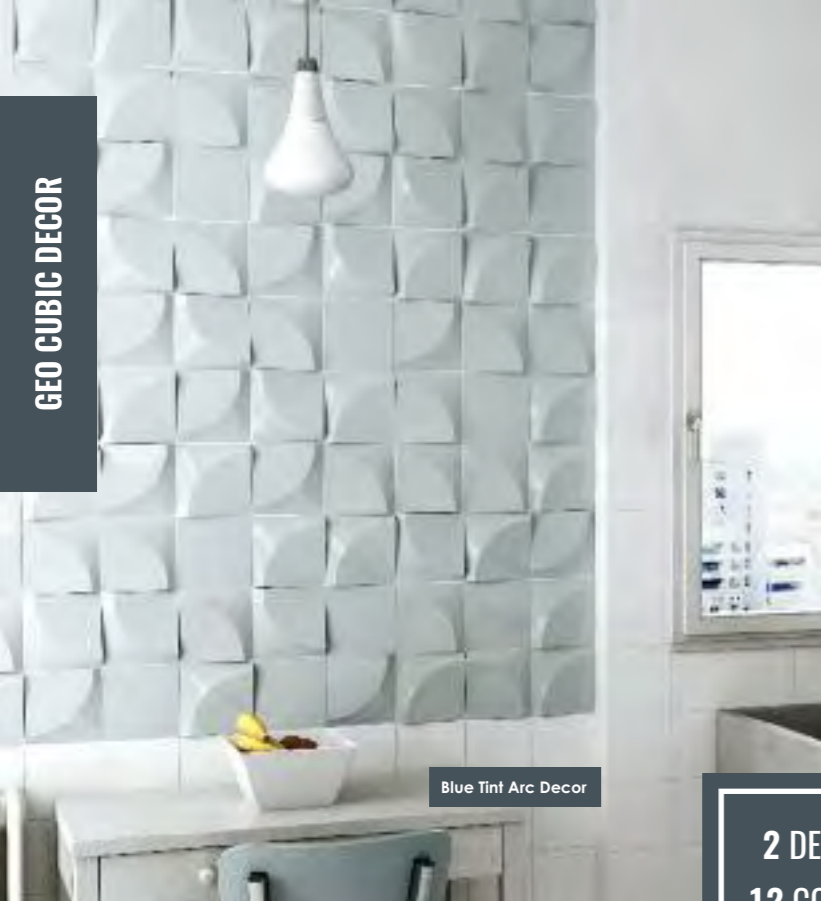

Blue Tint Arc Decor



Matt White & Black Tri Decor

2 DESIGNS
12 COLOURS
2 FINISHES



Matt White Arc Decor



Gold & Matt Black Arc Decor



Dark Grey Tri Decor

GEO CUBIC DECOR

- GE-50/
Gloss White
- GE-51/
Matt White
- GE-52/
Cream
- GE-53/
Pale Grey
- GE-54/
Green Tint
- GE-55/
Blue Tint
- GE-56/
Almond
- GE-57/
Dark Grey

- GE-61/
Gloss Black
- GE-62/
Matt Black
- GE-70/
Lustre
- GE-72/
Gold

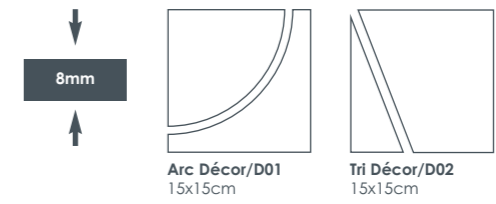

Wall Tiles:
Available in all sizes and colours

Matt finish: ■

Gloss finish: ●

Metallic finish: ▲

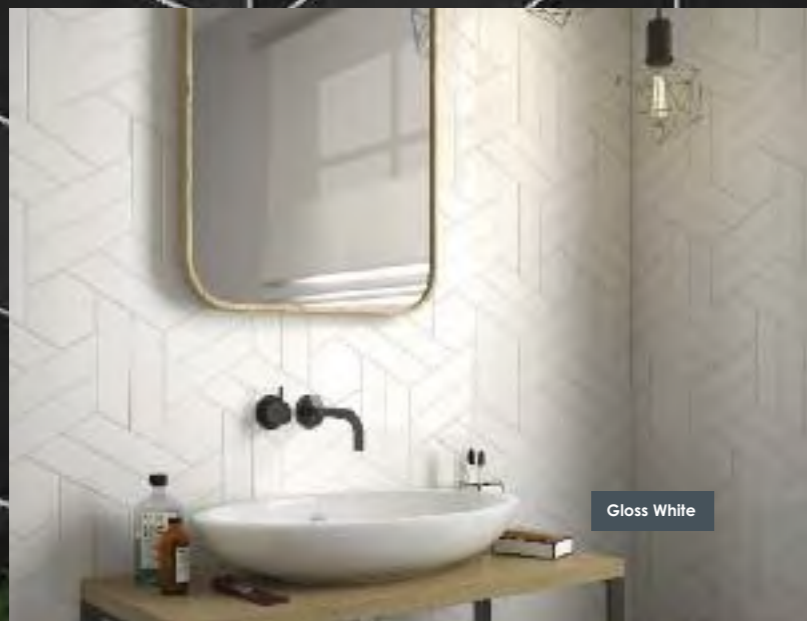
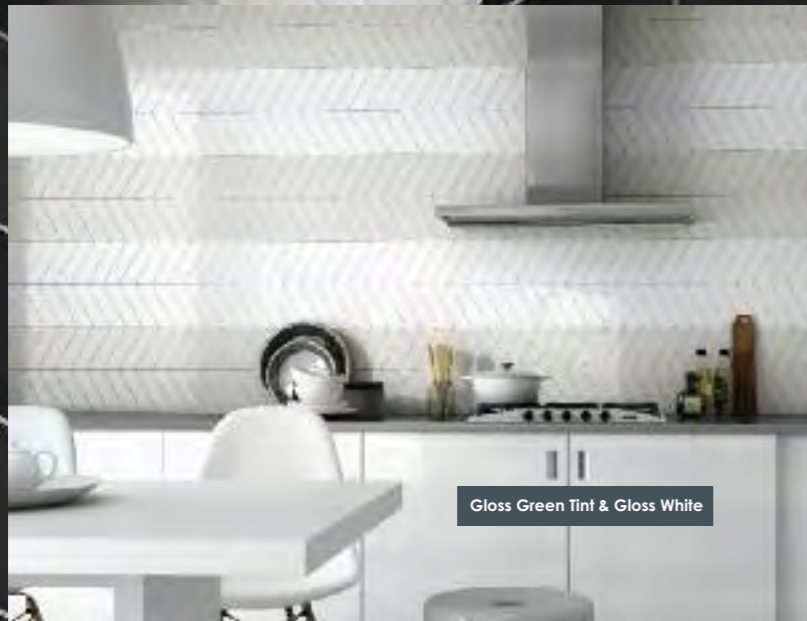

GE-50/20 Left
GE-50/21 Right
Gloss White



GE-51/20 Left
GE-51/21 Right
Matt White

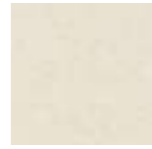

GE-52/20 Left
GE-52/21 Right
Cream



GE-53/20 Left
GE-53/21 Right
Pale Grey



GE-54/20 Left
GE-54/21 Right
Green Tint



GE-55/20 Left
GE-55/21 Right
Blue Tint



GE-56/20 Left
GE-56/21 Right
Almond



GE-57/20 Left
GE-57/21 Right
Dark Grey



GE-61/20 Left
GE-61/21 Right
Gloss Black



GE-62/20 Left
GE-62/21 Right
Matt Black

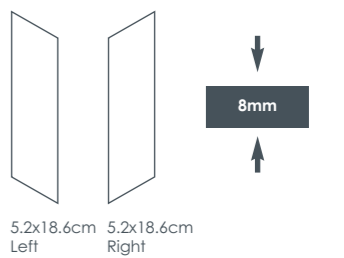

Matt finish: ■

Gloss finish: ●

Various laying proposals are available, example shown below

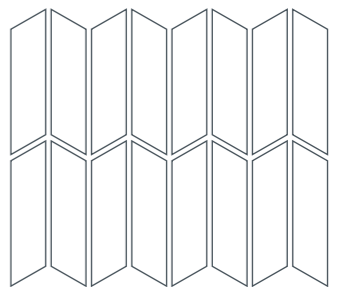

GEO RHOMBUS

Matt Black & Gloss Black



GEO LANTERN

GEO LANTERN

Gloss White, Pale Grey, Dark Grey & Gloss Black

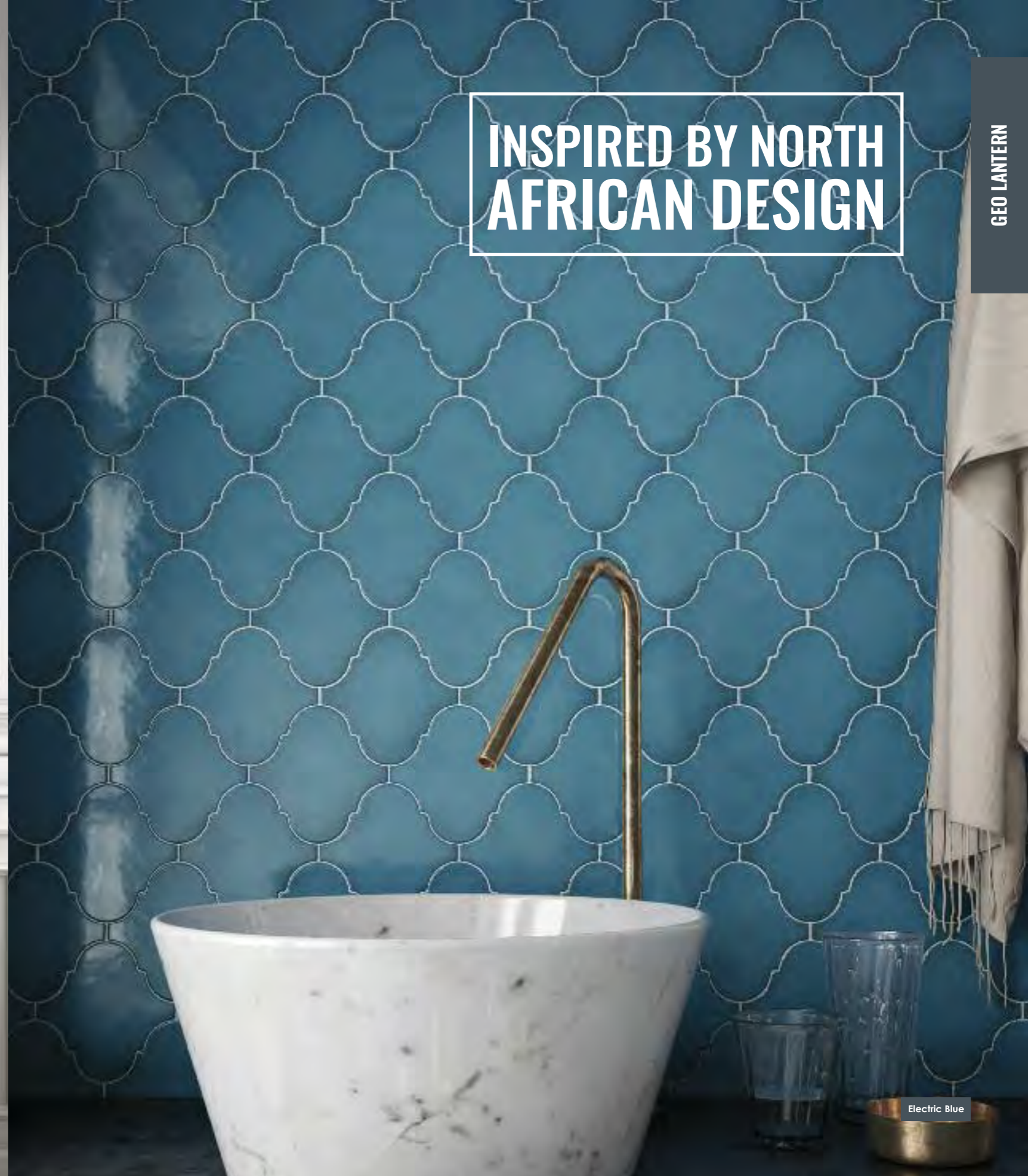

INSPIRED BY NORTH AFRICAN DESIGN

GEO LANTERN

							
GE-50/11 Gloss White	GE-51/11 Matt White	GE-52/11 Cream	GE-53/11 Pale Grey	GE-54/11 Green Tint	GE-55/11 Blue Tint	GE-56/11 Almond	GE-57/11 Dark Grey

			
GE-61/11 Gloss Black	GE-62/11 Matt Black	GE-72/11 Gold	GE-73/11 Electric Blue



- Matt finish: ■
- Gloss finish: ●
- Metallic finish: ▲



GEO HEX

Gloss White

TESSELLATION TILES
Available in Matt, Gloss and Metallic Finish



Cream, Pale Grey & Dark Grey











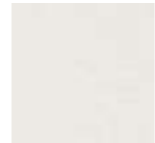

Blue Tint

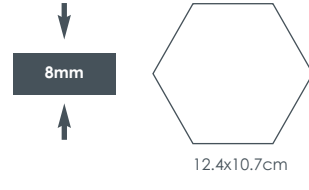
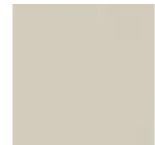

GEO HEX

White, Black, Pale Grey & Dark Grey

GEO HEX

						 <p>8mm</p> <p>12.4x10.7cm</p>
GE-50/15 Gloss White ●	GE-51/15 Matt White ■	GE-52/15 Cream ●	GE-53/15 Pale Grey ●	GE-54/15 Green Tint ●	GE-55/15 Blue Tint ●	
						<p>Matt finish: ■</p> <p>Gloss finish: ●</p> <p>Metallic finish: ▲</p>
GE-56/15 Almond ●	GE-57/15 Dark Grey ●	GE-61/15 Gloss Black ●	GE-62/15 Matt Black ■	GE-72/15 Gold ▲	GE-73/15 Electric Blue ▲	



Gloss White & Gold Parasol Decor

2 DESIGNS
13 COLOURS
3 FINISHES



Gloss White & Electric Blue Parasol Decor



Matt Black & Gloss White Peak Decor

GEO HEX DECOR

Introducing Peak and Parasol Decors



Gloss White & Electric Blue Peak Decor

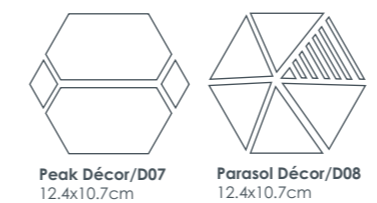

8mm

Matt finish: ■
Gloss finish: ●
Metallic finish: ▲

GEO SECTOR



Electric Blue



Gloss White



Gloss Black

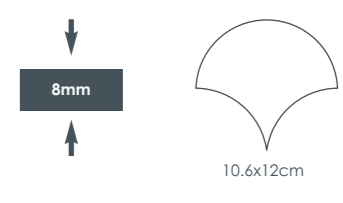
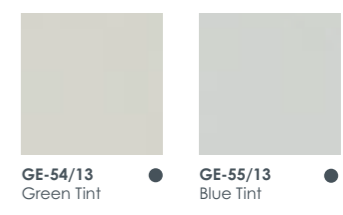

- Matt finish: ■
- Gloss finish: ●
- Metallic finish: ▲



12
COLOURS



Electric Blue



Gloss White, Pale Grey & Dark Grey



GE-50/17
Gloss White

GE-51/17
Matt White



GE-52/17
Cream

GE-53/17
Pale Grey



GE-54/17
Green Tint

GE-55/17
Blue Tint



GE-56/17
Almond

GE-57/17
Dark Grey



GE-61/17
Gloss Black

GE-62/17
Matt Black

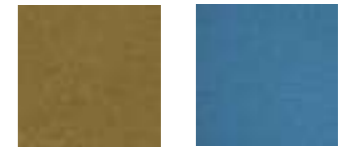

GE-72/17
Gold

GE-73/17
Electric Blue

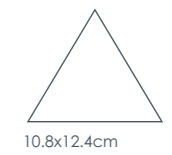

Matt finish: ■

Gloss finish: ●

Metallic finish: ▲

GEO TRI

CREATE DISTINCTIVE DESIGNS

Matt Black & Gold



PALMA

2 SIZES
6 COLOURS
GLOSS FINISH

Blanco & Nero



Gris



PALMA

HANDMADE RUSTIC EFFECT
PALMA

Azure

								
PL-400 Azure	PL-401 Blanco	PL-402 Crema	PL-403 Gris	PL-404 Nero	PL-405 Verde	9mm	10x10cm	6.5x20cm

Gloss finish available in all sizes and colours



DORSET

**13 COLOURS
MIXED DECOR
4 SIZES**

Pale Blue





Patchwork Decor & Ivory



DORSET

DORSET

Gloss Anthracite & Brocade Decor

							
DR-20 Matt White	DR-21 Gloss White	DR-22 Matt Anthracite	DR-23 Gloss Anthracite	DR-24 Pale Grey	DR-25 Pearl	DR-26 Graphite	DR-27 Pale Blue
					↓ 8mm ↑		
DR-28 Ivory	DR-29 Beige	DR-30 Mink	DR-31 Tobacco	DR-32 Pale Green			

 13.2x13.2cm
/10

 6.5x20cm
/20

 6.5x40cm
/30

 13.2x40cm
/40

13.2x13.2cm are only available in Gloss White, Gloss Anthracite, Pale Grey, Ivory Beige and Mink

Special pieces are available

DR-50/10
Patchwork Decor
13.2x13.2cm - Randomly Mixed

DR-20/21 Brocade Decor
Matt White - Available in all colours
6.5x20cm

Matt finish: ■

Gloss finish: ●

HAVANA



Teal



Honey

STAND OUT FROM THE CROWD



HV-10 White



HV-11 Cream

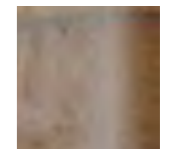

HV-12 Honey



HV-13 Burgundy



HV-14 Teal

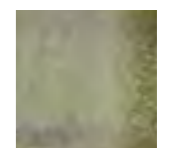

HV-15 Mint



HV-16 Blue

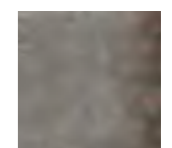

HV-17 Tobacco



15x25cm

Burgundy

DOWNTOWN

VISUALLY STRIKING



Mocha & Latte Arch with White



Latte Pyramid with White

Chocco Pyramid with White



Arch
15x30cm



DT-42
Latte



DT-43
Mocha



DT-44
Chocco

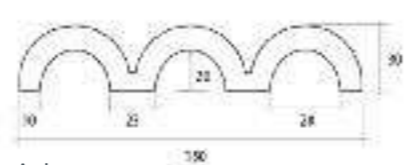

Arch
measurements in mm



DT-30
White



7.5x30cm

Matt finish



Pyramid
12.5x30cm



DT-52
Latte



DT-53
Mocha



DT-54
Chocco

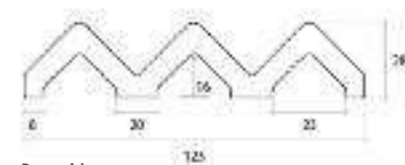

Pyramid
measurements in mm



DT-30
White



7.5x30cm

Matt finish



SPLIT

SLEEK ASPIRATIONAL DESIGN



Lines and Transition tiles are available in all colours

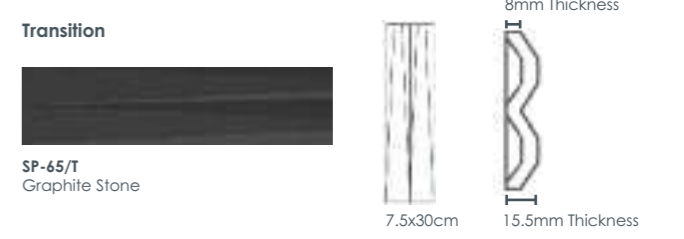
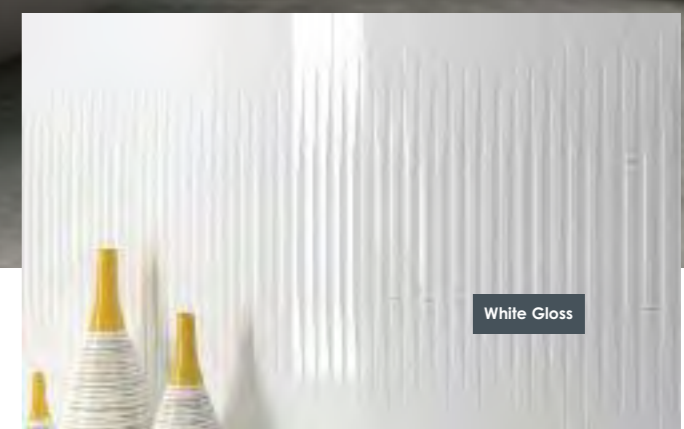
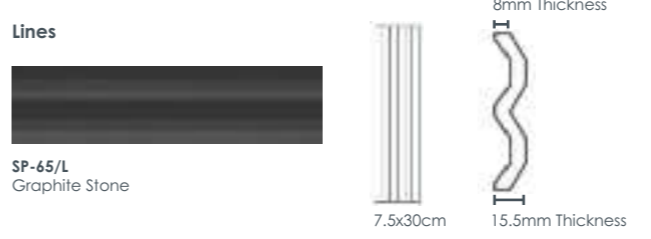
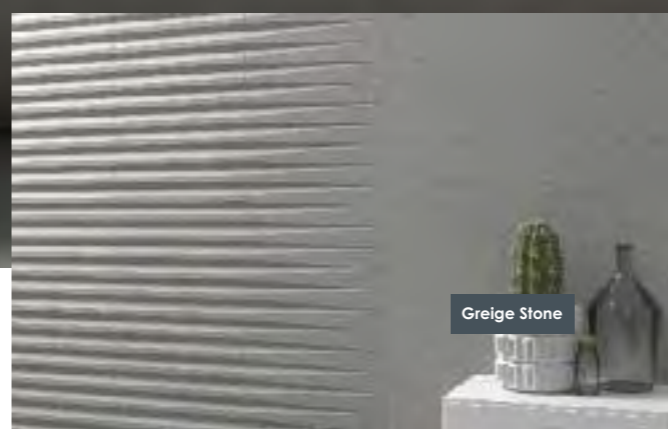



MANILA

ADD SOME COLOUR



- 
MA-50
White
- 
MA-52
Moonlight
- 
MA-53
Grey
- 
MA-54
Taupe
- 
MA-55
Brown
- 
MA-56
Mint
- 
MA-57
Teal
- 
MA-58
Sunset

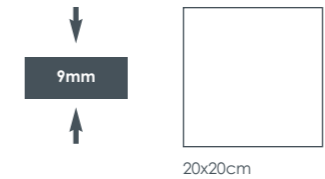

Wall Tile:
Each colour consists of four designs as shown with the MA-59 Pumpkin

N SERIES

PLAIN COLOUR - VITRIFIED
WALL AND FLOOR



Ottoman, Singapore and Lunar

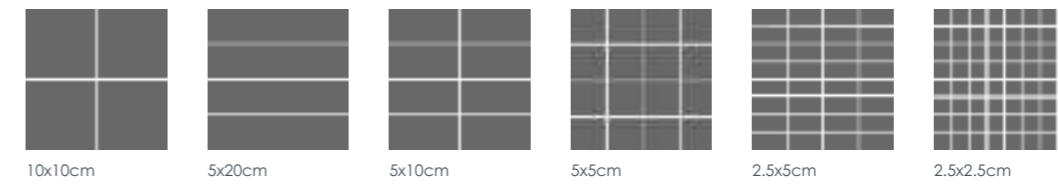

Pre Formed grooved pieces are available in 20x20cm
Available colours are marked with *

Anti-Slip and Special Pieces are also available

AS/AR Gloss and matt ceramic wall tiles available in the same colour pallet

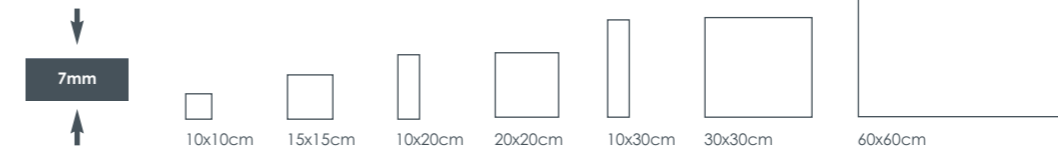

N-04 Monsoon*	N-01 Huntingdon	N-07 Windsor	N-10 Queensland*	N-09 Ardennes*	N-00 Farnham*	N-05 Minster	N-15 Harmony
N-03 Mercury	N-02 Arran*	N-18 Dalam*	N-80 Macau	N-99 Lowry*	N-12 Perth	N-14 Bavaria	N-83 Lakeside*
N-81 Oriental	N-21 Warsaw	N-42 Moorish*	N-30 Lutina	N-32 Namibia	N-40 Ottoman*	N-87 Sahara*	N-98 Arena*
N-88 Madras*	N-96 Flame	N-97 Lunar*					

Available colours in 10x10cm & 20x20cm formats only

N-85 Thornbury	N-86 Belize*	N-89 Nepal*	N-90 Verona	N-41 Cadiz	N-70 Saigon	N-72 Singapore*	N-44 Barbados
N-45 Antigua	N-43 Planet	N-37 Colombo	N-38 Amazon	N-23 Chameleon*	N-82 Arghyll	N-17 Istanbul	N-95 Forest*
N-19 Esagoni	N-94 Emilia	N-93 Prism	N-91 Munich	N-84 Chelo			



Celeste Diamond

















Polar



Matt Dark Plain Hexagon

APOIDEA

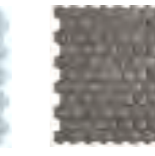
ADD MAGIC TO YOUR MOSAIC

						
AP-150/D Pearl Diamond	AP-171/D Lilac Diamond	AP-170/D Celeste Diamond	AP-158/D Midnight Diamond	AP-174/D Sapphire Diamond	AP-175/D Ruby Diamond	AP-308 Polar
						
AP-409/D Matt Light Grey Diamond	AP-408/D Matt Dark Grey Diamond	AP-410/D Matt White Diamond	AP-403/D Matt Black Diamond	AP-425/D Matt Light Blue Diamond	AP-426/D Matt Frappe Diamond	AP-300 Carrara

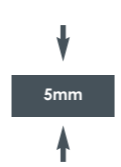

Glass Mosaic:
All Matt colours are also available in Plain Hexagon

Anti-Slip finish Available in Polar & Carrara
Anti-Slip Rating: Shod PTV +36



APOIDEA

INSPIRED BY EARTH'S
NATURAL TONES

Sapelly Mix Hexagon



Light Oak Diamond



Blue Patchwork



AP-202 Cotto



AP-209 Beige



AP-203 Blue



AP-205 Beige Patchwork



AP-206 Blue Patchwork



AP-200 Light Oak Plain



AP-201/D Light Oak Diamond



AP-201 Dark Oak Plain



AP-201/D Dark Oak Diamond



AP-134/D Forest Mix Hex Diamond



AP-135/D Sapelly Mix Hex Diamond



Glass Mosaic:
Anti-Slip finish Available in Dark Oak
Anti-Slip Rating: Shod PTV +36

TEXTURA 1

7 LAYOUT PROPOSALS

6 TEXTURES

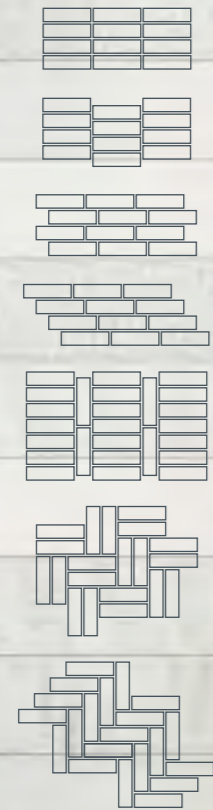

Grey & White

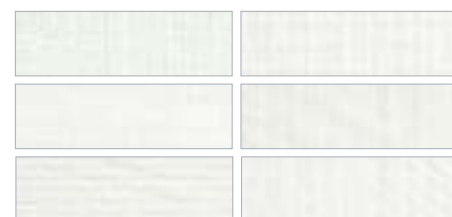

TX-311
White

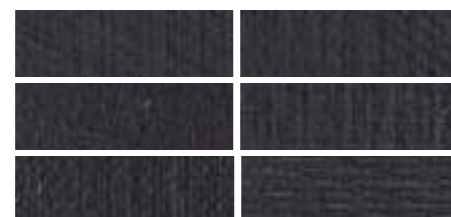

TX-312
Black



TX-313
Grey

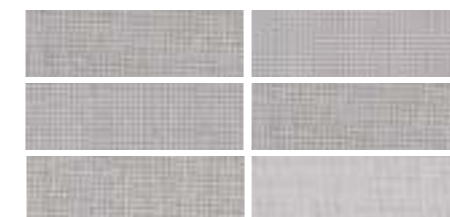

TX-314
Light Grey

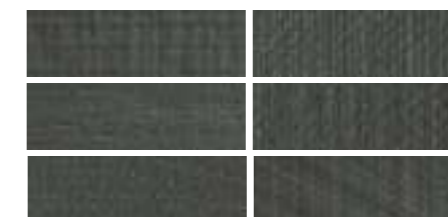

TX-315
Graphite



Suitable for walls and floors
Rating: Shod R10



TEXTURA 2

MAKE A STATEMENT

7 LAYOUT PROPOSALS
6 TEXTURES



TX-321
Black



TX-322
White

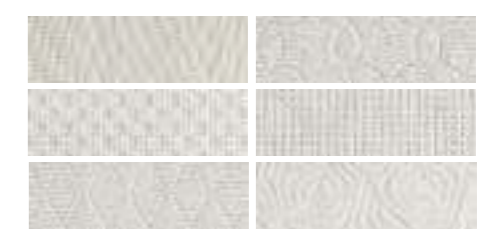

TX-323
Linen

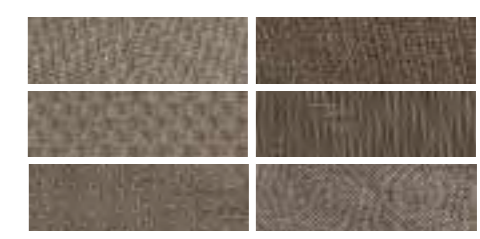

TX-324
Ecru

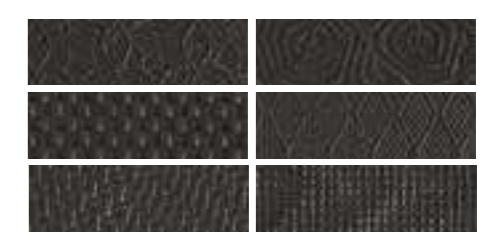

TX-325
Brown

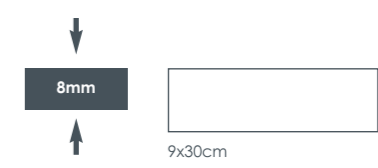

Suitable for walls and floors
Rating: Shod R11 - PTV +36

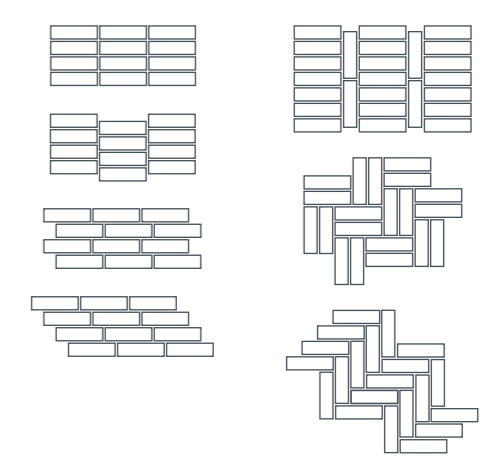

Black

KAYAMA

INSPIRED BY ISOMETRICS



Blue

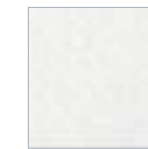

KY-90
White



KY-91
Cream



KY-92
Grey



KY-93
Blue

Square Decor



KY-90/S
White



KY-91/S
Cream



KY-92/S
Grey



KY-93/S
Blue

Cube Decor



KY-90/C
White

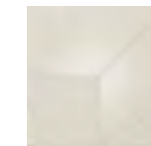

KY-91/C
Cream



KY-92/C
Grey

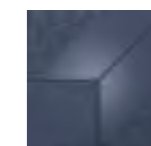

KY-93/C
Blue



30x30cm

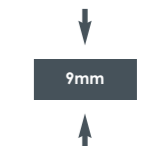

9mm

Matt finish:

Suitable for walls and floors
Rating: Shod PTV +36





Light Grey & White



Black, Dark Grey & White

DIAMOND

							
DM-80/S White	DM-81/S Cream	DM-82/S Taupe	DM-83/S Light Grey	DM-84/S Dark Grey	DM-85/S Black	14x24cm	

		
DM-86/T Red	DM-87/T Violet	DM-88/T Green



DM-85/T
Black

Smooth finish only available in White, Cream, Taupe, Light Grey, Dark Grey and Black

Textured finish available in all colours. Rating: Shod R10 - PTV +36, Barefoot C. Textured finish consists of four different textured tiles as shown

Various layout proposals are available



Grey, Cream and Brown Chevron



Matt White Hexagon & Frame Decor

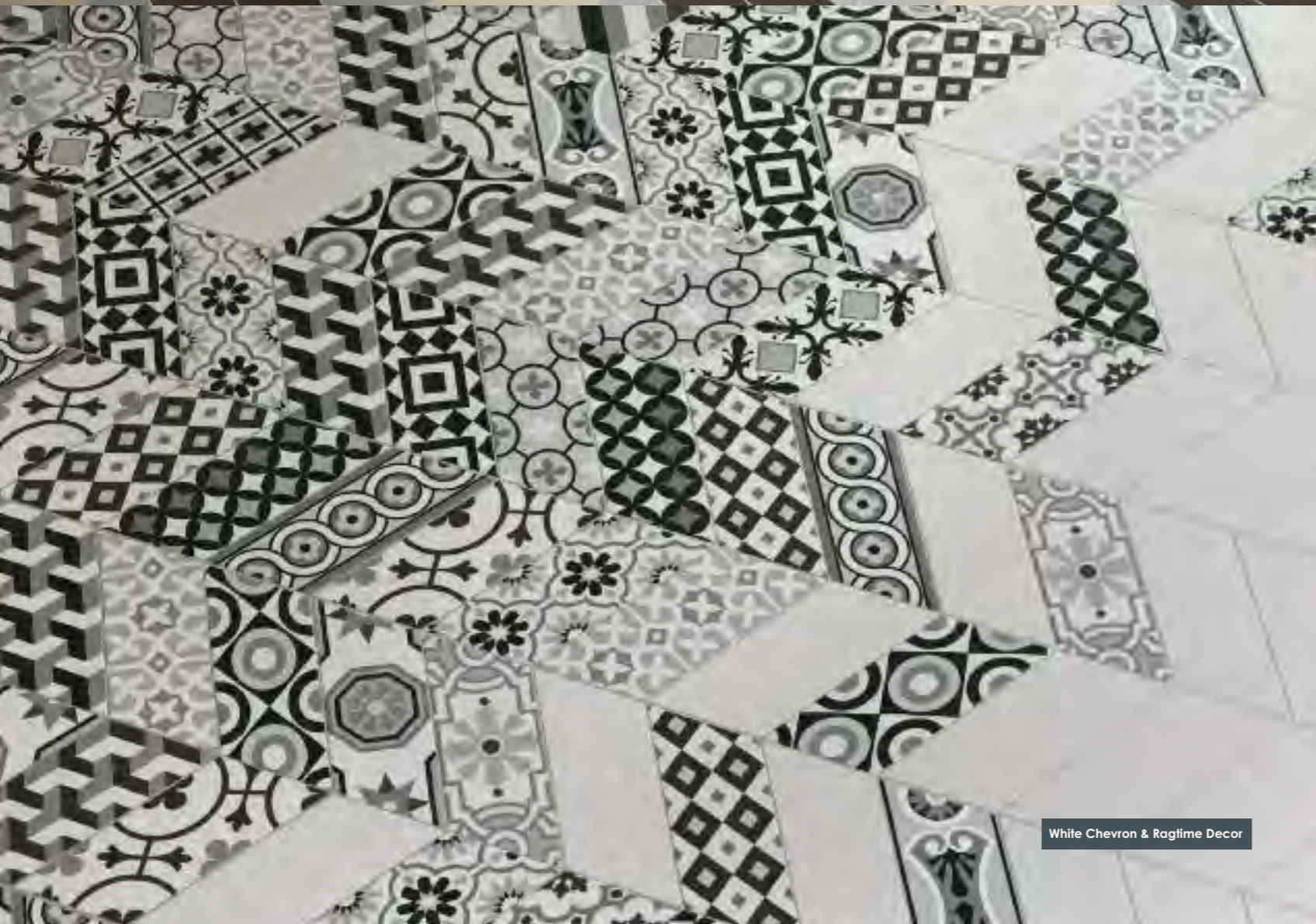

White Chevron & Ragtime Decor

CHEVRON + DECORS HEXAGON + DECORS GEO FLOOR

				
GE-81/30 Hexagon GE-81/31 Chevron Left GE-81/32 Chevron Right Matt White	GE-82/30 Hexagon GE-82/31 Chevron Left GE-82/32 Chevron Right Cream	GE-83/30 Hexagon GE-83/31 Chevron Left GE-83/32 Chevron Right Brown	GE-84/30 Hexagon GE-84/31 Chevron Left GE-84/32 Chevron Right Grey	GE-85/30 Hexagon GE-85/31 Chevron Left GE-85/32 Chevron Right Black
			↓ 8mm ↑	
Chevron 9x20.5cm Left	Chevron 9x20.5cm Right	Hexagon 17.5x20cm		

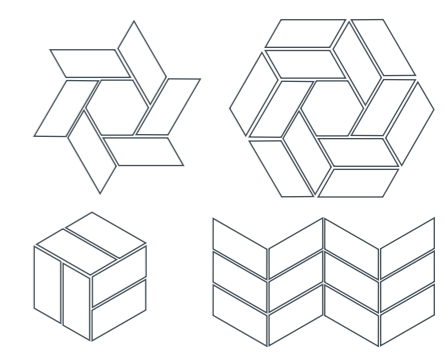

A selection of decors are available in both the Hexagon and Chevron shapes
Various laying proposals are available



White Grain Hexagon and Walnut Chevron



Light Oak Chevron & Hexagon



TRADITIONAL MEETS CONTEMPORARY

GEO WOOD FLOOR

Walnut Chevron



GE-90/30 Hexagon
GE-90/31 Chevron Left
GE-90/32 Chevron Right
White Grain

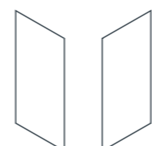

Chevron
9x20.5cm
Left



GE-91/30 Hexagon
GE-91/31 Chevron Left
GE-91/32 Chevron Right
Grey Ash



Hexagon
17.5x20cm



GE-92/30 Hexagon
GE-92/31 Chevron Left
GE-92/32 Chevron Right
Oak

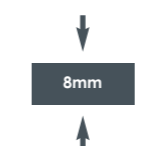

Chevron
9x20.5cm
Right



GE-93/30 Hexagon
GE-93/31 Chevron Left
GE-93/32 Chevron Right
Light Oak



Chevron
9x20.5cm
Left



GE-94/30 Hexagon
GE-94/31 Chevron Left
GE-94/32 Chevron Right
Walnut

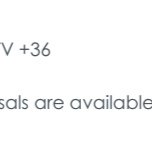

Chevron
9x20.5cm
Right

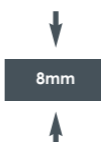

Mat finish:
Rating: Shod R10 - PTV +36

Various laying proposals are available

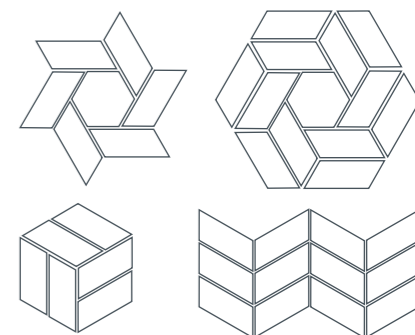



Grid 2 Decor

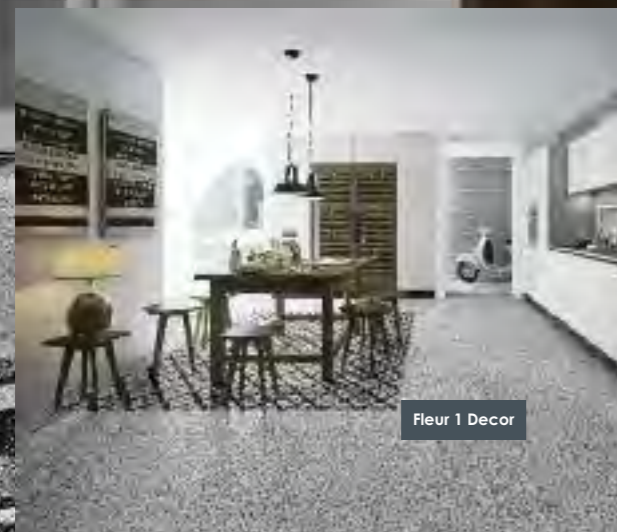

Fleur 1 Decor



Squares, Eclipse and Stripe Decor



MN-180
Black



MN-181
Grey



MN-182
White



MN-191
Fleur 1 Decor



MN-192
Fleur 2 Decor



MN-193
Fleur 3 Decor



MN-194
Grid 1 Decor



MN-195
Grid 2 Decor



MN-196
Star Decor



MN-197
Squares Decor



MN-198
Eclipse Decor



MN-199
Stripe Decor

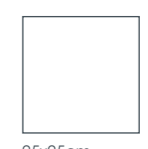

Natural finish
 Rating: Shod R10 - PTV +36
 Decors are also available
 as a random mix

MONUMENTA

INSPIRED BY TERRAZZO WITH STYLE



VINTAGE

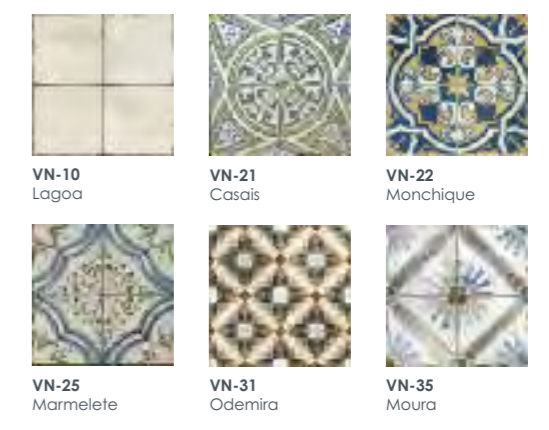

VN-10
Lagoa

VN-21
Casais

VN-22
Manchique

VN-25
Marmelete

VN-31
Odemira

VN-35
Moura



45x45cm



Mat finish Rating: Shod PTV +36

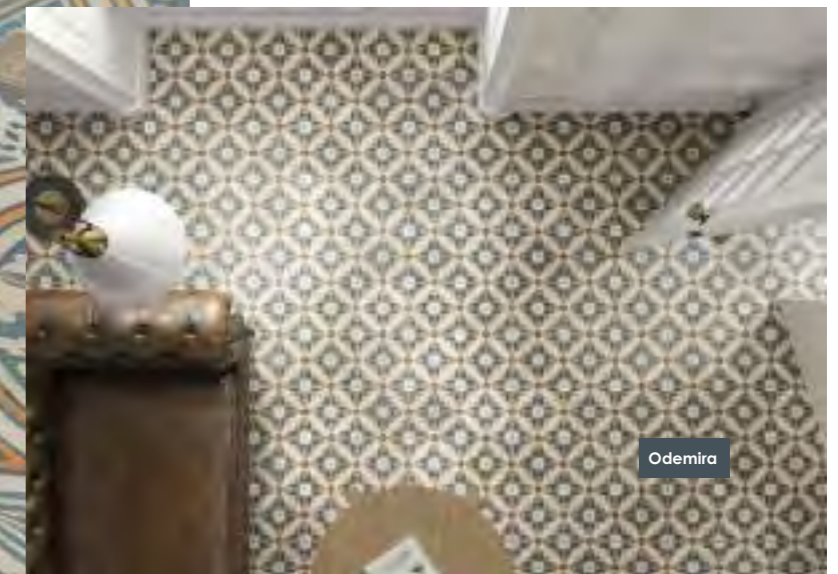

Odemira



Lagoa & Marmelete

Casais

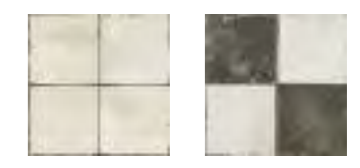

VN-10 Lagoa



VN-41 Corchas



VN-42 Ladeira

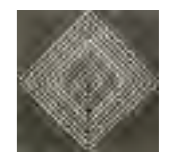

VN-44 Oleiro

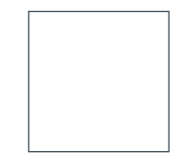

45x45cm



10.5mm

Mat finish Rating: Shod PTV +36



Corchas

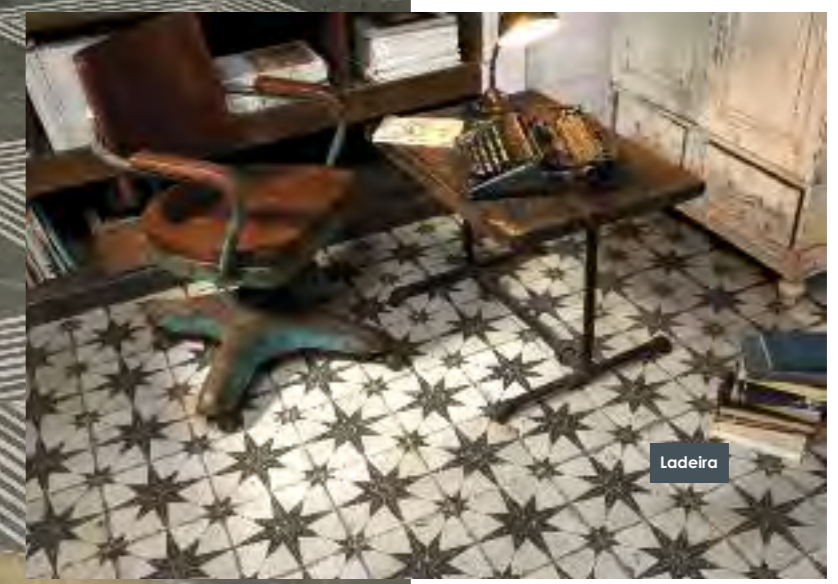

Ladeira

Oleiro

VINTAGE



ARTE DI CASA

AC-257



AC-260



ARTE DI CASA

ARTE DI CASA

COLOUR

AC-253

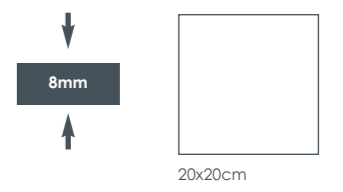

Matt finish
 Rating: Shod PTV +36
 * Made up of different designs that are randomly mixed in each box



AC-272



AC-273



AC-277

ARTE DI CASA

BLACK & WHITE

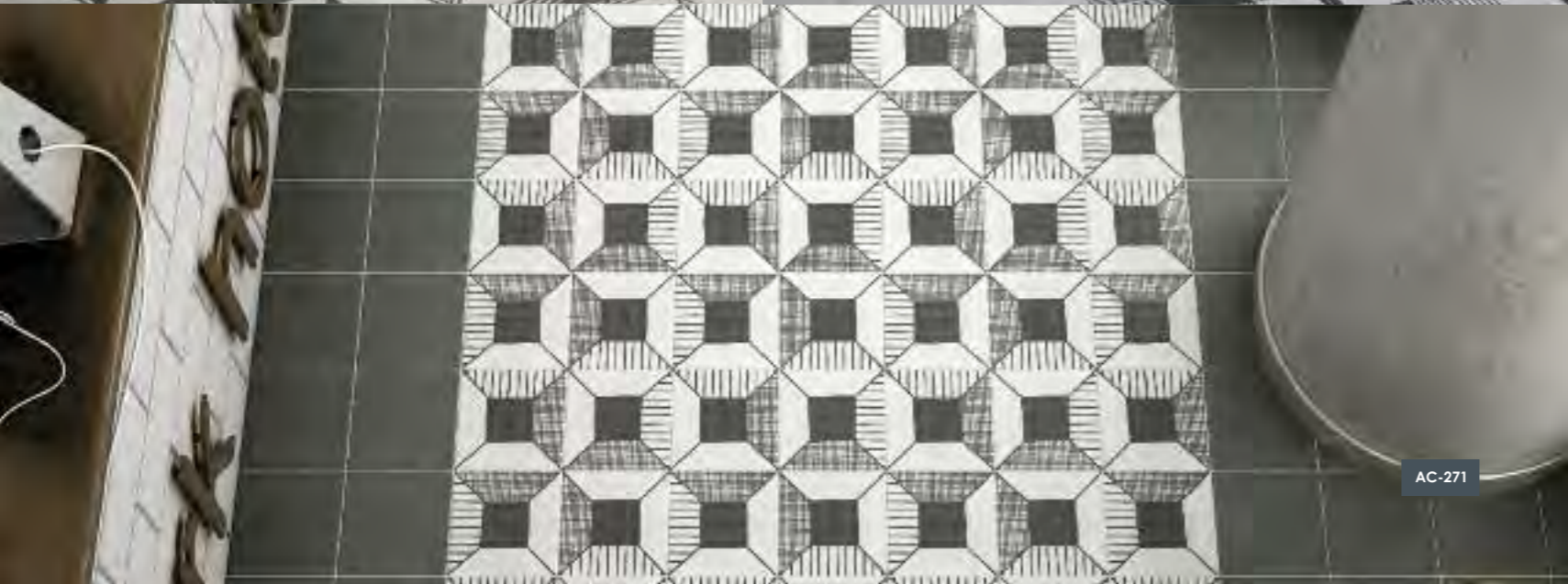

AC-271



AC-270



AC-271



AC-272



AC-273



AC-274



AC-275



AC-276



AC-277



AC-280*



8mm



20x20cm

Mat finish
Rating: Shod PTV +36

* Made up of different designs that are randomly mixed in each box

BARCELONA

THE LOOK OF ENCAUSTIC



Greco Decor



Sand Decor



Cube Decor



Mar Decor



BARCELONA



Blanco



Piedra



Gris



Night Decor



Classic Decor



Mar Decor



25x25cm

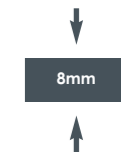

8mm

Matt finish Rating: Shod R10 - PTV +36



Triumph Decor



Arch Decor



Sand Decor



Cube Decor



Greco Decor



Star Decor



WINCKLEMAN'S



Everything started for Théophile Winckelmans in 1894 when he opened an unglazed tile factory in Lomme in Northern France.

Five generations have followed since then, sustaining the legacy and know-how of the founder whilst meeting the challenges specific to each era: the World Wars and bombing of the factory along with globalisation and the need to open up to export are some of the challenges successfully overcome which have allowed the factory to remain on its original site for so many years.

After the opening up to the world and rapid development of exports initiated by Jacques Winckelmans in the 1990s, the beginning of the 2000s was a difficult time for the factory which had to make some radical changes. The fifth generation currently at the helm thus decided on a major change of gear, with major investment in production and a move upmarket for the product. Our company has now achieved global recognition for the quality of its tiles and gained the trust of prestigious names in such diverse fields as haute couture and restoration as well as of known personalities.

Today, it is Barbara, Jacques daughter, who is carrying on with the legacy of the product and maintaining the family values that are key to the survival of our tiles.

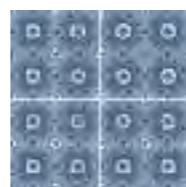
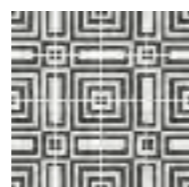

A Natural and Authentic Product

Our fully vitrified unglazed fine tiles are made of natural materials (mainly clay) from France and Europe which produce a non-porous tile, the ideal, versatile product for all types of residential, commercial and industrial projects.

Easy maintenance and excellent stain resistance thanks to near-zero porosity

The absorption rate of under 0.5% of our fully vitrified tiles makes them stain-resistant and they can therefore be used in the dampest locations with no fear of them changing colour or appearance. This low porosity makes them easy to clean and renders any post-installation treatment or specific cleaning products superfluous. They can be used in such varied projects as professional kitchens, public swimming pools and so on.

Through-body colours and patterns

Our tiles are through-body, which gives them an identical colour throughout their thickness and a service life of several centuries thanks to the lasting shades and patterns.

A lasting, versatile product thanks to its exceptional technical characteristics

Fired at a temperature close to 1,200 degrees Celsius, our unglazed tiles are compact and have excellent technical characteristics. They are robust enough to be used commonly outside, they are heat- and frost-resistant and suitable for intensive use areas.

Plain colours



Format	Size (cm)	Thickness (mm)
Square	1.2x1.2	3.8 / 5
	2x2	3.8
	3.5x3.5	9
	5x5	5 / 9
	7x7	9
	10x10	9 / 11
	15x15	9
	20x20	9
Rectangle	2.35x5	5
	2.5x15	9
	5x15	9
	5x10	9
	10x20	9
Hexagon	2.5x2.5	3.8 / 9
	5x5	5
	10x10	9
Octagon	15x15	9
	10x10	9
	15x15	9
Triangle	3.5x3.5x5	9
	5x5x7	9
	7x7x10	9
	10x10x14	9
Round	8.5x8.5x14.6	9
	1.8	3.8 / 9
Cross	7x7	9
Diamond	5	5
Shuttle	15x7	9

Formats - Shapes & Sizes

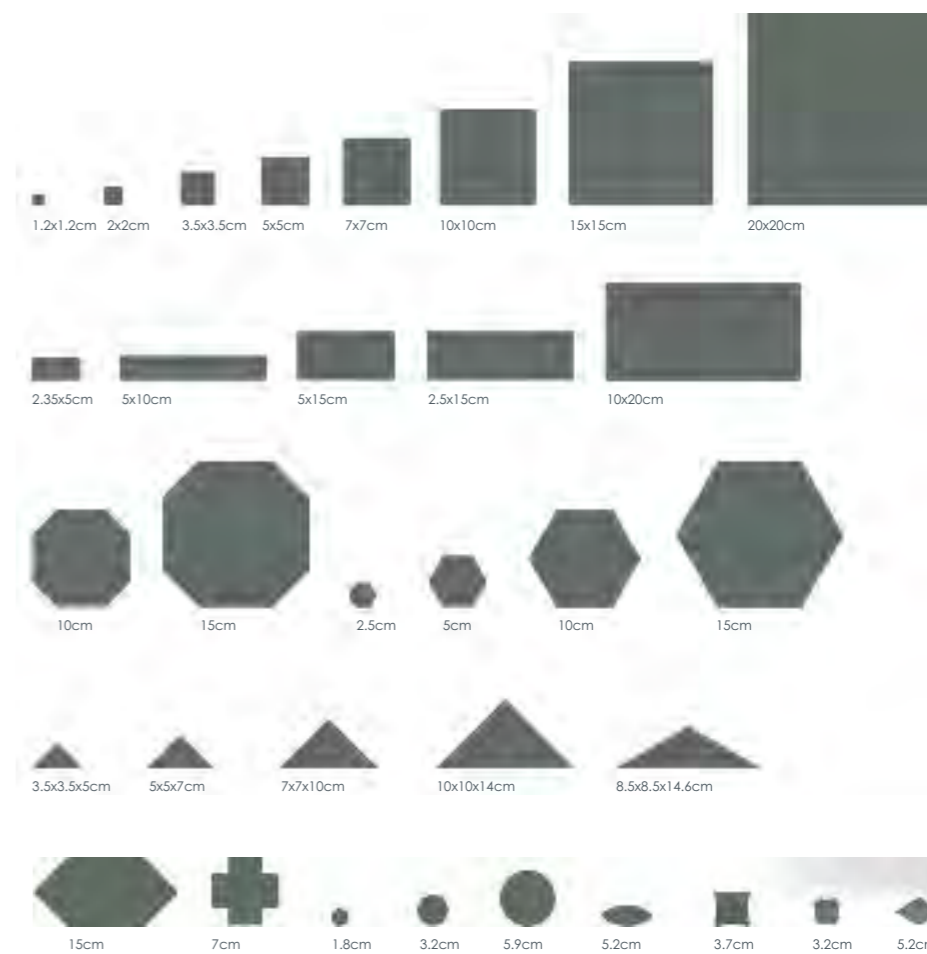

Finishes:

Natural finish Rating: Shod R10 - PTV +36, Barefoot B
Rice Grain Anti-Slip Rating: Shod R10 - PTV +36, Barefoot C
Orange Peel Anti-Slip Rating: Shod R11 - PTV +36, Barefoot C

Anti-Slip ratings may vary depending on tile size



SQUARES

Our squares are central in our range and can be used singly or with other formats. The timeless patterns shown here like the check or more complex designs match all styles of project perfectly.

Available sizes and thickness:

1.2x1.2cm	3.8/5mm
2x2cm	3.8mm
3.5x3.5cm	9mm
5x5cm	5/9mm
7x7cm	9mm
10x10cm	9mm
15x15cm	9mm
20x20cm	9mm

Available surface finishes:

- Natural
- Rice Grain Antislip (5x5cm & 10x10cm)
- Orange Peel Antislip (10x10cm)



Plain Colour 2x2cm
Assembled on sheets of 30.8x30.8cm
Black



2x2cm Design "Grid"
Assembled on sheets of 30.8x30.8cm
Black, Australian Green, Dark Green, Green, Pale Green, Pistachio, Super White



Checker 10x10cm
Loose or assembled on sheets of 30.7x30.7cm
Black, Super White



2x2cm Design "Couture"
Assembled on sheets
Pearl Grey, Super White, Yellow

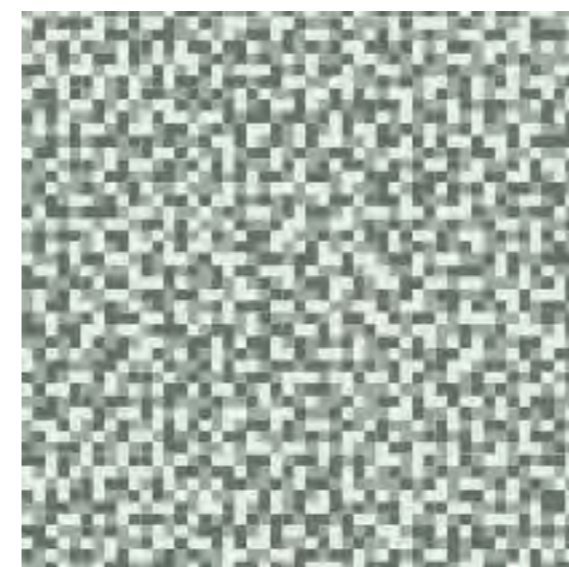

Random Mix 2x2cm
Assembled on sheets of 30.8x30.8cm
34% Super White, 33% Pale Green, 33% Dark Green



15x15cm Squares + 5x5cm Dots
15x15cm squares and dots are provided loose
Black 15x15cm, Pearl grey 5x5cm Dots



RECTANGLES



Brickbond 2.35x5cm Rectangles
Assembled on sheets of 29.2x31.8cm
Ivory



BD03 Wave Pattern 2.35x5cm Assembled
Assembled on sheets of 29.2x31.8cm
Super White, Black, Pearl Grey

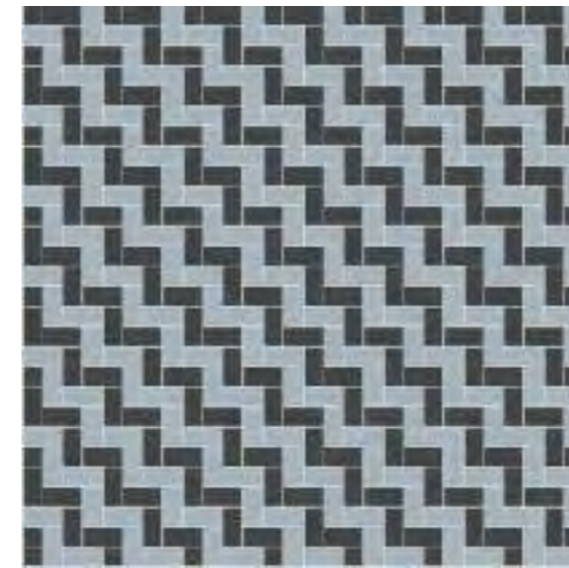

BA02 Herringbone Pattern 2.35x5cm Assembled
Assembled on sheets of 28.4x28.4cm
Pale Blue, Black

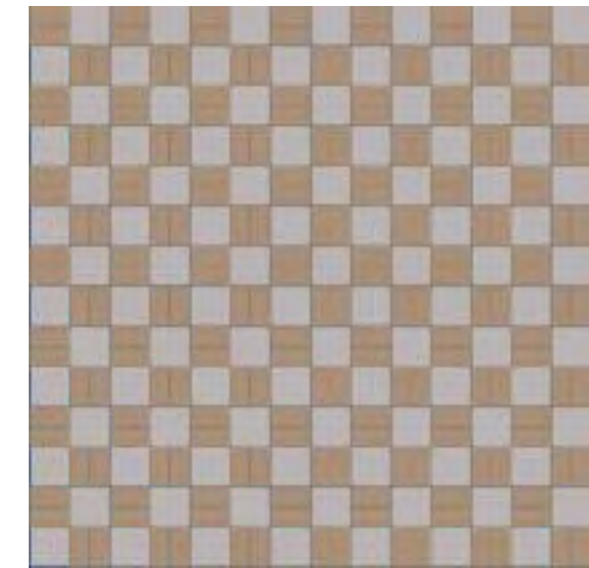

BC01 Chequer Pattern 2.35x5cm Assembled
Assembled on sheets of 31.8x31.8cm
Old Pink, Parma

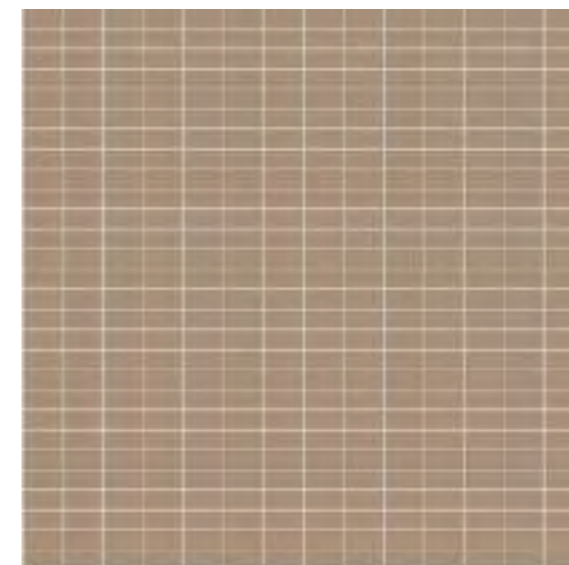

Straight 2.35x5cm Rectangles
Assembled on sheets of 31.8x31.8cm
Old Pink

Our rectangles are available in several sizes and are used alone or combined with other formats for composition purposes (borders and floor designs)

Available sizes and thickness:

2.35x5cm	5mm
2.5x1.5cm	9mm
5x10cm	9mm
5x15cm	9mm
10x20cm	9mm / 18mm

Available surface finishes:

Natural



HEXAGONS

The hexagon is an unrivalled traditional format for all types of project. Traditionally used in a single shade like Provence floor tiles, it also has many pattern options.

Available sizes and thickness:

2.5cm	3.8 / 9mm
5cm	5mm
10cm	9mm
15cm	9mm

Available surface finishes:

Natural



Soccer Ball 10cm Hexagons
Loose or assembled on sheets
Pearl Grey, Black



Flower 1 10cm Hexagons
Loose files
Pearl Grey, Super White, Blue, Black



Flower 2 10cm Hexagons
Loose or assembled on sheets
Pistachio, Super White, Dark Green



Diamond 2.5cm Hexagons Assembled
Assembled on sheets
Black, Super White, Yellow



Net 2.5cm Hexagons
Assembled on sheets
Pearl Grey, Brown, Yellow, Super White



Lantern 2.5cm Hexagons Assembled
Assembled on sheets
White, Red

OCTAGONS & DOTS



Classic Bicolour Pattern

Loose tiles (except for the border) or assembled on sheets of 30.7x30.7cm
White 10cm Octagons, Black 3.5cm Dots
Border Ref: Cavendish



Bicolour Dots

Loose tiles (except for the border) or assembled on sheets of 30.7x30.7cm
Anthracite 10cm Octagons, Super White 3.5cm Dots, Black 3.5cm Dots
Border Ref: Nottingham

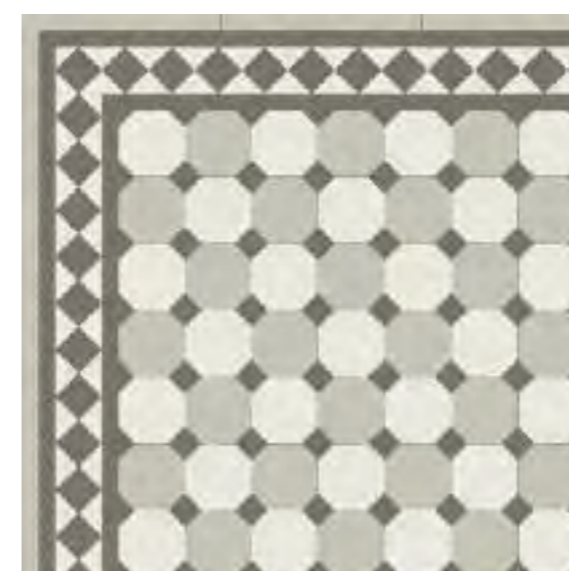

Octagons Checker Pattern

Loose tiles (except for the border) or assembled on sheets of 30.7x30.7cm
Pearl Grey 10cm Octagons, Super White 10cm Octagons, Anthracite 3.5cm Dots
Border Ref: Cavendish



Classic Bicolour Pattern

Loose tiles (except for the border) or assembled on sheets of 30.7x30.7cm
Blue Moon 10cm Octagons, Pearl Grey 3.5cm Dots
Border Ref: Glasgow

Octagons and dots are a timeless, traditional combination and bring a touch of authenticity to your project.

Available sizes:

10cm Octagons (+ 3.5cm dots)
15cm Octagons (+ 5cm dots)

Available surface finishes:

Natural



Multicoloured Dots

Loose tiles (except for the border)
Red 15cm Octagons, White 5cm Dots, Black 5cm Dots
Border Ref: Tottenham

TRIANGLES



Triangles are used alone like our isosceles triangles or with other formats as part of a layout.

Available Sizes
Right-angled Triangles:
3.5x3.5x5cm
5x5x7cm
7x7x10cm
10x10x14cm

Isosceles Triangles:
8.8x8.8x14.6cm

Available surface finishes:
Natural

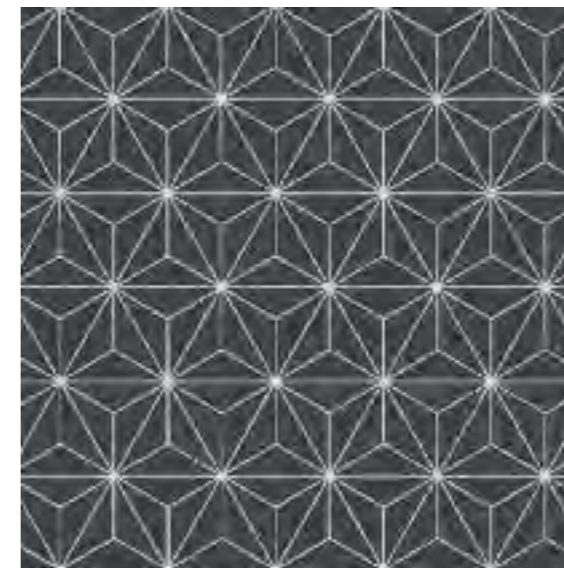

Plain Colour - Isosceles Triangle
Assembled on sheets
Black



Random Mix - Isosceles Triangle
Assembled on sheets
Pale Green, Pale Blue, Pink, Cognac, Linen, Yellow, Super White, Dark Green



Triangles and Hexagons
15cm Hexagons are provided loose and isosceles triangles are provided on sheets
Black Isosceles Triangles, Super White 15cm Hexagons



ROUNDS & DIAMONDS

Rounds:

Available sizes (diameters) and thicknesses:

- 1.8cm 3.8mm/9mm
- 3.2cm 3.8mm/9mm
- 5.9cm 3.8mm/9mm

Diamonds:

Available sizes (length) and thicknesses:

- 5cm 5mm

Available surface finishes:

- Natural

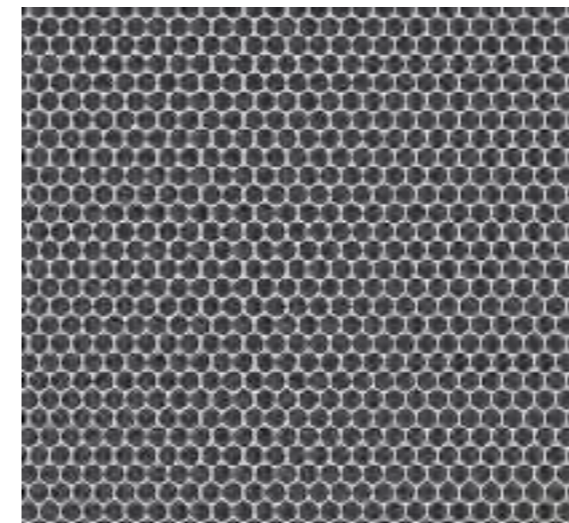

Rounds - Plain Colour 1.8cm Rounds
Assembled on sheets of 30x28cm
Black

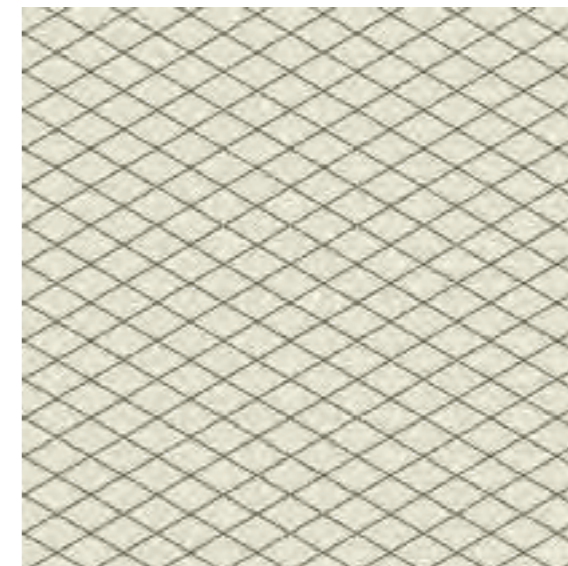

Diamonds - Straight Formation
Assembled on sheets
White Diamonds

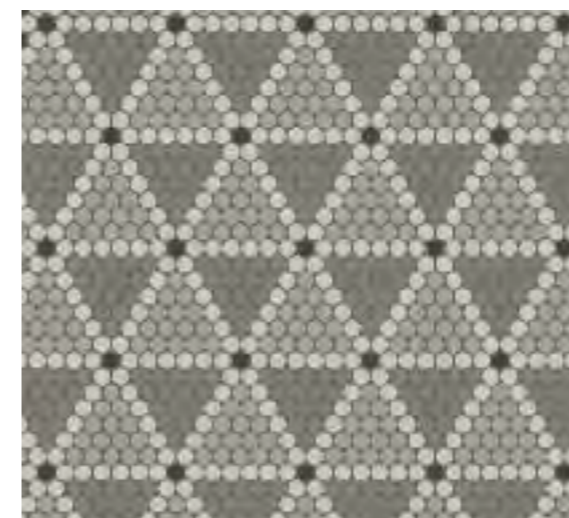

Rounds - Triangle Design 1.8cm Rounds
Assembled on sheets
Linen, Taupe, Coffee

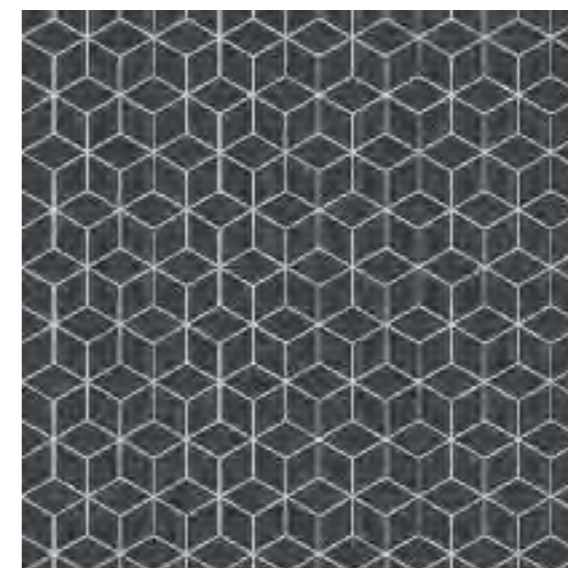

Diamonds - Alternate Formation
Assembled on sheets
Black Diamonds



Rounds - Hexagon Design 1.8cm Rounds
Assembled on sheets
Dark Blue, Vanilla, Pale Blue, Black, Pearl Grey

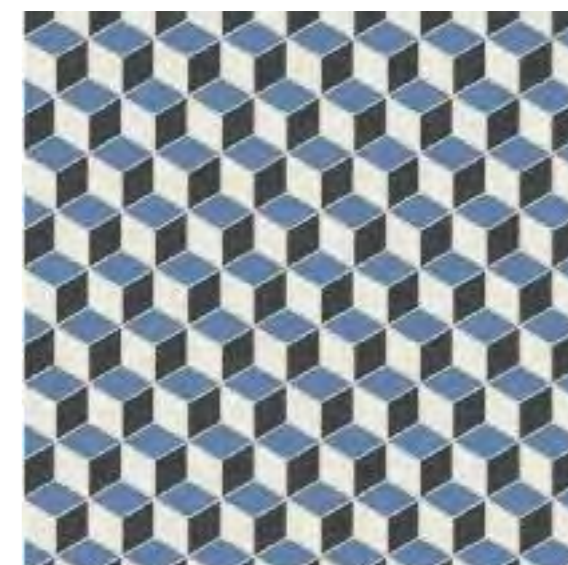

Diamonds - Trump L'oeil Design
Assembled on sheets
Black, Super White, Dark Blue

MOSAIC COMBINATIONS

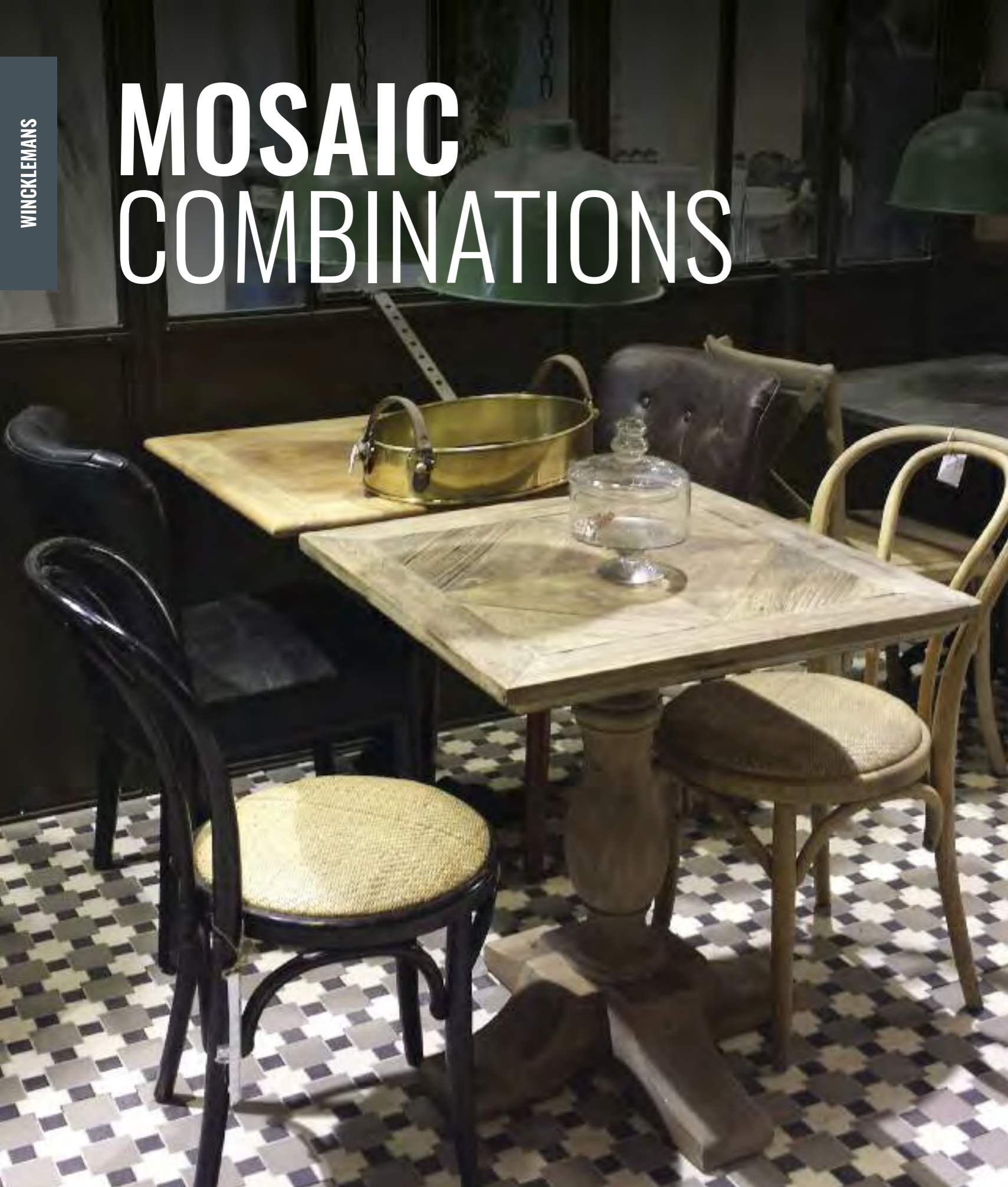

Assembly packaging

All patterns shown opposite are supplied assembled on sheets for easy installation.

Colours

Each part of the compositions shown can be customised with your choice of colours. Please contact us for customised layouts matching your ideas.



Honeycomb
Assembled on sheets of 28.9x28.9cm
Black 3.5cm Crosses, Vanilla 1.8cm Rounds



Textile
Assembled on sheets of 32.7x32.7cm
Super White 7cm Crosses, Taupe 3.5cm Dots, Black 7x7cm

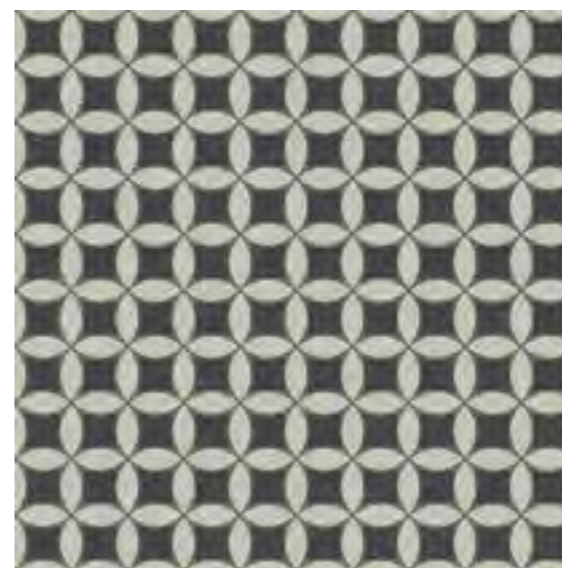

Eclipse
Assembled on sheets of 29.7x29.7cm
Black 3.2cm Stars, Pearl Grey 5.2cm Ellipses

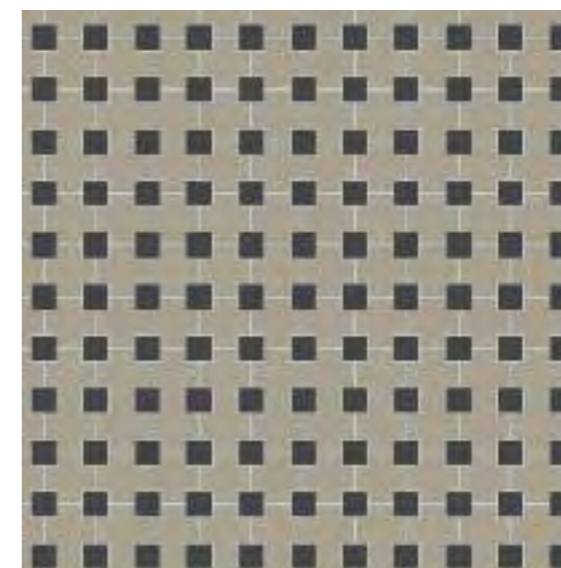

Reef Knot
Assembled on sheets of 28.7x27cm
Pale Grey 7cm Crosses, Black 3.5cm Dots



Tetrix
Assembled on sheets of 27.1x25.3cm
White 7cm Crosses, Black 7cm Crosses

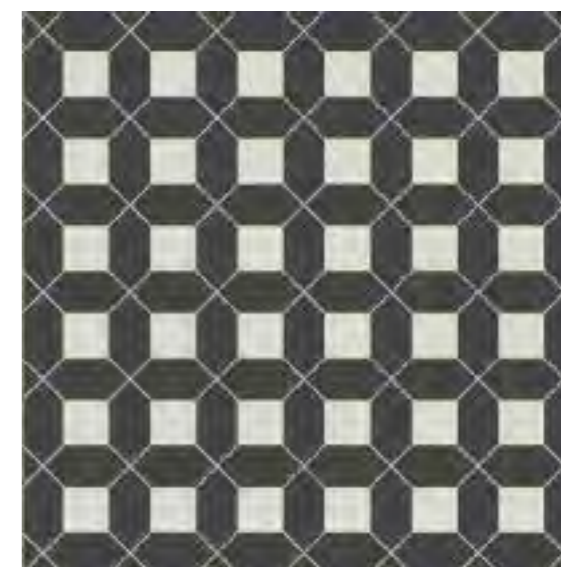

Church
Assembled on sheets of 33.9x33.9cm
Black Shuttles, Super White 7x7cm



DESIGNS & BORDERS

Designer Range

Packaging

All our floor designs and borders are supplied pre-assembled on sheets of about 30x30 cm for easy installation. Caution, floor designs and borders are supplied separately so any border can be used with your choice of floor design.

Joints

Floor designs and borders assembled edge to edge and supplied without joint. Some floor designs have an alternative version with standard joints. Please ask for further information.

Models

Some borders are presented with plain squares around them which are used here for aesthetic purposes only.

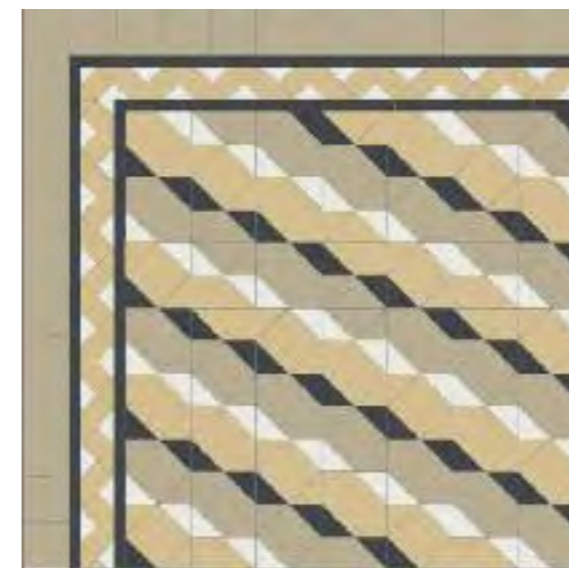

Detroit - Design & Border
Colours:
Linen, Cognac, Black, Super White



San Francisco - Design & Border
Colours:
Black, Super White, Charcoal, Pearl Grey



Houston - Design & Border
Colours:
Grey, Super White, Yellow, Black



Seattle - Design with Tottenham Border
Colours:
Pale Grey, Super White, Black, Green, Ontario



Philadelphia Design & Annandale Border
Colours:
Charcoal, Super White, Black, Pearl Grey



Washington - Design & Border
Colours:
Black, Super White, Pale Grey



Brighton - Design & Border
Colours:
Black, White, Red, Linen



Glasgow - Design & Border
Colours:
Black, Super White, Charcoal, Pale Grey



Bristol - Design & Border
Colours:
Black, White, Red



Leeds - Design with Windsor Border
Colours:
Black, White



Chelsea - Design & Border
Colours:
Blue Moon, Black, Super White, Pearl Grey



Nottingham - Design & Border
Colours:
Black, Super White, Grey

DESIGNS & BORDERS

Victorian Range

Packaging

All our floor designs and borders are supplied pre-assembled on sheets of about 30x30 cm for easy installation. Caution, floor designs and borders are supplied separately so any border can be used with your choice of floor design.

Joints

Floor designs and borders assembled edge to edge and supplied without joint. Some floor designs have an alternative version with standard joints. Please ask for further information.

Models

Some borders are presented with plain squares around them which are used here for aesthetic purposes only.

ENCAUSTIC

Customisation of colours

Each section of tiles shown on this page can be customised using the range of plain colours. Customised renderings with the colours of your choice are available on request.

Creation or reproduction of patterns

The tiles shown in this catalogue are not exhaustive. Do not hesitate to send us your requests to reproduce existing patterns.

It is even possible to create entirely new patterns!

5x5cm



ENC27

ENC01

ENC06

7x7cm



ENC02

ENC07

ENC08

ENC09

ENC14

ENC15

10x10cm



ENC12

ENC02

ENC03

ENC04

ENC10



ENC11

ENC13

ENC FRI CN

ENC FRI

15x15cm



ENC06

ENC26